

LEE

LEE PRECISION, INC.
HARTFORD, WISCONSIN USA

CLASSIC RELOADING TOOLS

M A D E I N T H E

Heartland

New

**LEE CLASSIC CAST
POWDER MEASURE**

PAGE 18



Table of Contents

- 2 Introduction to Reloading
- 3 Introduction to Reloading
- 4 Reloading Stand · Bench Plate
- 5 Modern Reloading II · Lee Loader
- 6 Reloading Kits
- 7 Reloading Kits
- 8 Presses · Breech Lock Challenger
Reloader · Breech Lock Hand Press
- 9 Turret Press
- 10 Classic Cast Overview
Breech Lock Classic, Classic Cast
- 11 Classic Cast Overview
Classic Cast Turret Press
- 12 Pro 1000
- 13 Load-Master
- 14 Zip Trim · Case Conditioning Tools
- 15 Quick Trim Case Trimmer
- 16 Auto Prime XR · Ergo Prime
- 17 Powder Measures · Auto Drum
- 18 Classic Powder Measure
- 19 Perfect Powder Measure · Scale
- 20 Pistol Dies Overview
- 21 Pistol Dies Overview
- 22 Pistol Die Sizes · Exclusive Features
- 23 Pistol Die Sizes · Exclusive Features
- 24 Rifle Dies · PaceSetter · RGB
- 25 Rifle Dies · Collet · Ultimate
- 26 Rifle Die Sizes
- 27 Rifle Die Sizes
- 28 Factory Crimp Dies
- 29 Factory Crimp Dies · Bulge Buster
- 30 Electric Melters
- 31 Lube & Sizing · Alox
- 32 Bullet Mold Overview
- 33 Bullet Molds Chart
- 34 Black Powder
- 35 Load-All II · Slug Mold
18 Cavity Buckshot Molds
- 36 Lee Guarantee

**Thanks for
your interest in
reloading**

IF YOU HAVE NEVER RELOADED BEFORE, you're in for a treat. While some would have you believe it is rocket science, nothing could be further from the truth. If you can replace a light bulb, that is (**screw in a die**); if you can measure with a teaspoon (**dip a powder charge**); if you can shove a cork into a bottle (**seat a bullet**) and can read and comprehend this description (**read instructions**) then you're all set.

HANDGUN

SIZE

PRIME

REMOVING spent primer and RESIZING case can be accomplished by using any reloading press

Pistol Sizing Die

Breech Lock Challenger Press pg 8

INSTALL PRIMER Can be done on press or by hand

On press: Prime with Lever Prime System pg 9

RIFLE

RESIZING LUBRICANT
INDUSTRIAL GRADE
PREVENTS BRASS CASES
FROM BEING OVER-
SIZED
DO NOT USE ON
LEAD CORED OR
S&W CASES
NET WEIGHT
1.5 OZ.

LUBRICATE an inspected, clean case. Note This step is omitted with Lee Collet Neck Sizing Die—usable only on fired cases that fit your gun

NOTICE how the case neck is expanded as case is withdrawn from the die

FOR SAFETY SAKE CHECK YOUR CASES for proper trim length. Chamfer inside case neck to allow easy bullet installation. Page 14

Rifle Sizing Die

On press: Prime with Ram Prime pg 16

Hand Priming with Lee Ergo Prime Page 16



A reloading press and a set of Lee Dies are all you need to start reloading. Lee Dies are complete with powder measure, shell holder and complete instructions, including load data that tells you how much and what type of powder to use. Dies and presses basically last a lifetime, so buying on what your budget allows

makes the most sense. You will never regret buying a value priced press—as no matter how sophisticated a press you own— you always have need for a simple press for odds and ends jobs. If you mount your press with the LEE BENCH PLATE, your second press is always at the ready. If you don't have a

workbench consider the LEE RELOADING STAND, built for the ultimate in rigidity and convenience. Reloading handgun and rifle cases have similarities but are different enough that we have broken the steps out into their own categories. All applicable products are shown.

CHARGE

SEAT & CRIMP



Auto Disk Powder Measure pg 17 Powder Funnel and Dippers pg 19

EXPAND THE CASE MOUTH AND CHARGE POWDER.
Lee handgun dies are unique in that you can charge powder during this operation



HANDGUN Powder Through Expanding Die

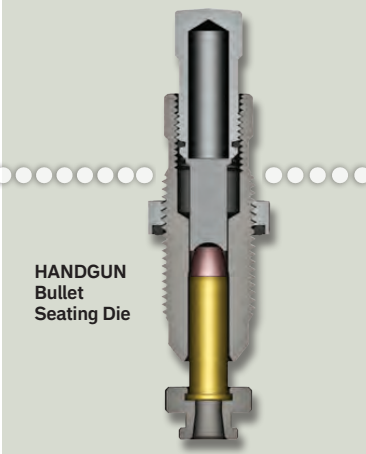

HANDGUN Bullet Seating Die

SEAT AND CRIMP THE BULLET



HANDGUN Carbide Factory Crimp Die

OPTIONAL FACTORY CRIMP DIE
In most circumstances will improve velocity, uniformity and in all cases, factory-like utility & dependability.

CHARGE POWDER



Perfect Powder Measure pg 18 Powder Funnel with Dipper pg 19

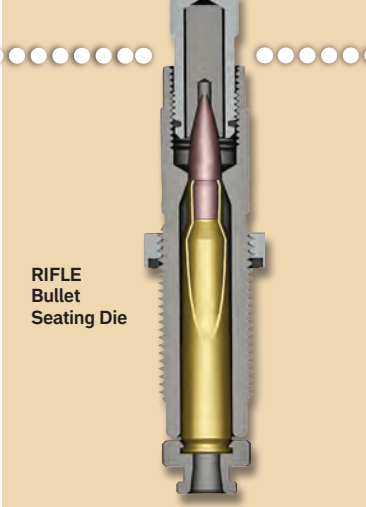

RIFLE Bullet Seating Die

SEAT THE BULLET

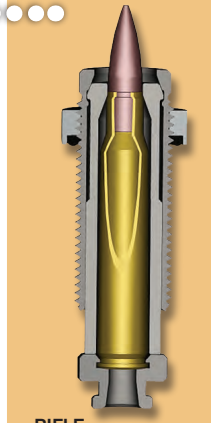

RIFLE Factory Crimp Die
The only effective way to crimp bottle neck cartridges

**LEE RELOADING STAND
BENCH PLATE**



Concrete block not included

Lee Reloading Stand

At last a reloading stand built just for your reloading needs. The sturdy powder coated steel stand places your press at the perfect counter stool or standing height. Three-leg design assures absolute stability regardless of the floor condition. Rubber tipped legs suitable for any surface. The thick steel top is fitted with the patented, quick change Lee Bench Plate System with steel base block

to fit all Lee metallic presses. The stand also includes a sturdy steel shelf with two bench plate receivers that will neatly and securely store your extra presses or mountable accessories. Each leg has eight mounting holes that allow you to accessorize your stand with a multitude of bins, shelves or accessory racks. Dimensions 39" high x 26" wide x 24" deep.

90688 134.00



ACCESSORIES



HARDWOOD BASE BLANKS

Precut hardwood blanks are a perfect fit for your Lee Bench plate or Reloading stand. Six hard to find elevator bolts with nuts and washers are included. This kit makes adding a new press or accessory to your reloading setup a delight.

90571 13.98



DIE RACK

Sturdy steel rack with fasteners designed for the Lee Reloading stand. Conveniently holds your dies at the ready especially helpful when loading small batches of ammo with frequent die changes. Can also be wall or bench mounted.

90680 12.00



BIN AND BRACKET

Sturdy steel bracket and parts bin. Includes fasteners to allow direct mounting to the Lee Reloading stand. Perfect for holding bullets, cases and loaded rounds.

90687 13.98



STEEL BASE BLOCK

Rigid, powder coated steel construction. First choice for mounting all current Lee Presses. Works with the Lee Reloading Stand and Bench Plate. Fasteners for mounting one Lee reloading press are included.

90267 15.00

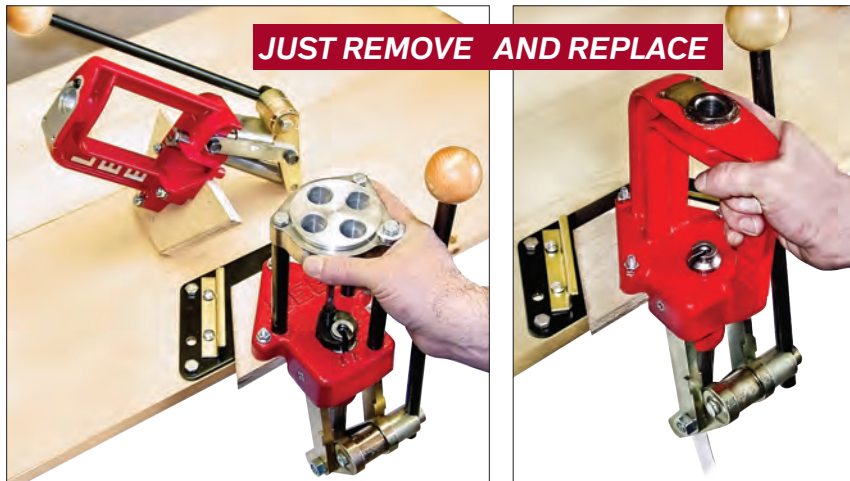

Patented design allows instant press change. So sturdy you can resize the monster 50 BMG case, then quickly switch to a smaller press for priming or other operations. Trapezoidal base block slides into perfect register and made immovable with the quick tightening of four bolts.

Lee Bench Plate turns you into a quick change artist!

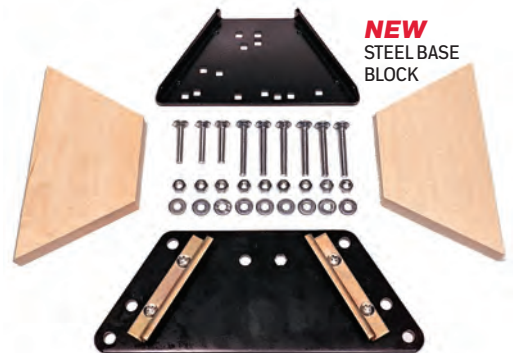

NEW
STEEL BASE
BLOCK

Lee Bench Plate

Includes steel base block and two (2) hardwood base blanks. Special hardware included mounts three presses. Powder coated, thick steel mounts quickly and securely to any bench or tabletop. Wide steel plate distributes load, adding rigidity to the lightest bench top.

90251 34.00

*Everything about reloading
with the world's
most comprehensive load data*

MODERN RELOADING SECOND EDITION

BY RICHARD LEE

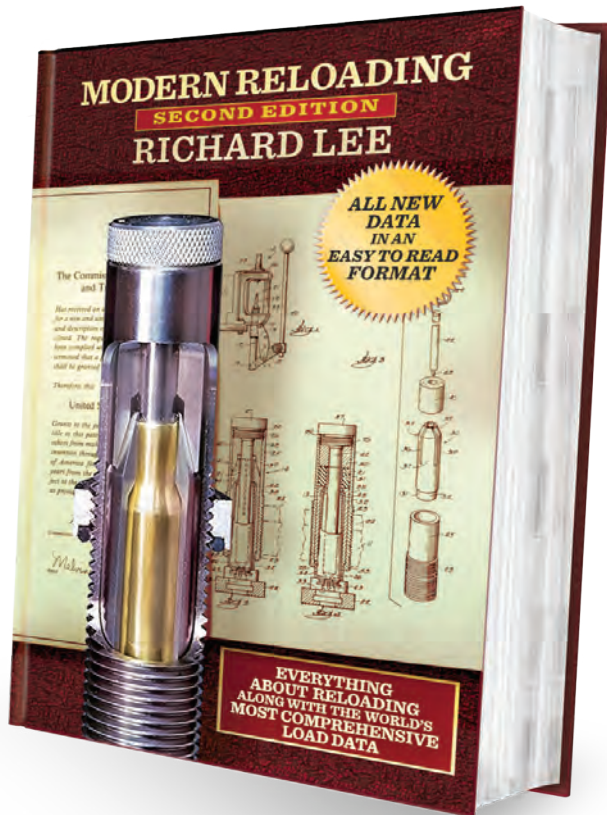

Learn to reload ammunition that is more accurate than your first try

The Second Edition of MODERN RELOADING is a summary of a lifetime of experience. No matter how knowledgeable you are, you will find new and interesting information in this book.

It is a reference book you will keep forever.

OVER 28,000 LOADS covering 167 cartridges in a new, larger, easier to read format, with velocities for starting loads. This is the best kind of load data — it is supplied by the powder companies.

NEW, LARGER, EASER TO READ FORMAT with computer rendered and dimensioned drawings. Cartridges tabbed for quick reference.

LATEST INFORMATION ON PRESSURE

EXCLUSIVE PRESSURE AND VELOCITY FACTORS enable you to accurately calculate pressure and velocity for reduced loads. An absolute necessity for cast bullet shooting.

A NEVER BEFORE PUBLISHED in depth analyses of current load data. It gives you insight into the effects of reducing or increasing a charge.

MODERN RELOADING SECOND EDITION 90277 **30.98**

LEE LOADER SIZES

22 HORNET	90265
223 REMINGTON	90232
22/250	90233
243 WINCHESTER	90235
6.5X55 SWEDISH MAUSER	90271
270 WINCHESTER	90240
7mm REM. MAGNUM	90242
7.62X54 RUSSIAN	90243
†30 M1 CARBINE	90253
30/30 WIN (30 REM.)	90244
308 WINCHESTER	90245
30/06 SPRINGFIELD	90248
303 BRITISH	90247
45/70 GOVERNMENT	90264
9mm LUGER	90254
38 SPECIAL	90257
357 MAGNUM	90258
‡44 MAGNUM	90260
‡45 ACP	90262
‡45 COLT	90263

The Classic Lee Loader

For more than 50 years, more shooters have chosen the famous Lee Loader for their first reloading tool than any other. They realize it is all they need for good, accurate ammunition. In fact, at one time ammunition loaded with a Lee Loader held a world record listed in the *Guinness Book of World Records* for more than seven years. Millions upon millions of rounds have been reloaded with the famous Lee Loader, and we expect it will continue to be a most popular reloader for many years to come. It's the perfect tool for those who wish to simply try reloading, because it will pay for itself in just an hour or two.

Find out for yourself how much fun it is to reload with the Lee Loader. Everything you need to begin loading one caliber and you'll save enough to pay for it in the first hour!

LEE LOADER **39.98**



‡ Calibers requiring considerable force for sizing.



LEE VALUE TRIM pg. 15
now shipping with this Kit

Breech Lock Challenger Kit

Features the same components as the 50th Kit, but we have replaced the SAFETY PRIME with the AUTO-PRIME XR and a set of Auto-Prime shell holders. This kit is for those who prefer to prime off the press. If purchased separately — a \$250.80 value. (Shown with optional Bench Plate. Order #90251)

90030 **186.00**

50th Anniversary Kit

The Breech Lock Challenger Press

includes [1] Breech Lock Quick Change Bushing
You get a complete Powder Handling System, with the most convenient and repeatable PERFECT POWDER MEASURE. Plus the LEE SAFETY SCALE, the most sensitive, safest of all powder scales. Fill your cases with the included POWDER FUNNEL. A value of \$169.94.

Case Preparation Tools include the LEE VALUE TRIM CASE TRIMMER to trim on your reloading press (order cartridge specific trim die separately), and a CUTTER & LOCK STUD to trim your cases. Order the correct CASE LENGTH GAUGE for the calibers you'll be loading; it's only \$5.98 extra. The LEE CHAMFER TOOL chamfers the inside and outside of the case mouth, and a tube of premium SIZING LUBE is also included. A small and large PRIMER POCKET CLEANING TOOL completes the case preparation package. \$31.90 value.

But that's not all! You get the Large and small SAFETY PRIME. Prime with push button convenience and is safe with all brands of primers. Never touch the primer from box to the case. \$30.00 value.

Reloading saves money. Save right from the start with Lee equipment.

Purchased separately — \$231.84
90050 **186.00**



Compare to others
priced at
hundreds of dollars more

50th Anniversary Kit

LEE VALUE TRIM pg. 15
now shipping with this Kit

Breech Lock Hand Press Kit

The perfect portable reloading press kit
Begin reloading at once. No wasted time mounting to a work bench. Pack it all in the box when finished. Great for apartment dwellers or loading at the range. DIES NOT INCLUDED.

BREECH LOCK HAND PRESS KIT INCLUDES

- BREECH LOCK HAND PRESS
- RAM PRIME
- POWDER FUNNEL
- CASE SIZING LUBE

90180 **78.00**



A SET OF LEE DIES AND THIS KIT IS EVERYTHING YOU NEED TO RELOAD!

Your best buy for loading both rifle and pistol cartridges!

Lee Value Turret Press Kit

The rugged Turret Press, along with the Auto Disk Powder Measure, produces top quality pistol ammo in a hurry.

A finished round with a few pulls of the lever. Disconnect the Auto-Index and it's large enough to handle monster belted magnum rifle cases. When it's time to change calibers, simply lock in a new turret and begin reloading in seconds. In addition to the Turret Press and Auto Disk Powder Measure, the kit includes the Lee Safety Scale, unmatched for sensitivity, a primer pocket cleaner, cutter and lock stud to trim the cases and a chamfer tool to deburr cases after trimming.

A set of Lee Dies is all that is required to complete this reloading outfit. And all of this at a price that will allow you to pay for your investment in a matter of hours.

4 HOLE TURRET W/AUTO INDEX 90928

199.00



The world's most popular turret press now available in a kit!

Classic Turret Press Kit

THIS KIT AND A SET OF LEE DIES is everything you need to begin reloading. The Classic Turret Press is fast and convenient when loading handgun cartridges, with rates in excess of 250 rounds per hour possible.

The kit includes the PRO AUTO-DISK powder measure and riser, perfect for all handgun and small rifle cartridges. Large and Small SAFETY PRIME are included making on press priming an ease. Instant change turret makes changing calibers a snap. Deactivate the auto-index and batch load the longest and largest rifle cartridges.

Complementing your press kit are the case conditioning tools to prepare your brass for loading. Includes CUTTER, LOCK STUD, CHAMFER TOOL, small and large PRIMER POCKET CLEANER, and a tube of LEE CASE SIZING LUBE. Complete it with the cartridge specific CASE LENGTH GAUGE. Verify your loads with the included LEE SAFETY POWDER SCALE.

Completing the kit is *MODERN RELOADING SECOND EDITION*, recently revised with all new load data covering 167 cartridges with over 28,000 loads.

90304 **306.00**



Lee Breech Lock Challenger Press

The "O" frame press by design is the strongest and the most popular style press by far. Large opening and long stroke handles the largest belted magnums with ease. The primer catcher is positive and routes the spent primers directly to the trash can. Priming is a dream with the LEE LEVER PRIME SYSTEM. Best of all, it includes the BREECH LOCK QUICK CHANGE DIE SYSTEM. Change dies instantly with a twist of the wrist; you'll never have to re-adjust your die.

Other features include all steel linkage with adjustable length lever. This same press will cost you more than twice as much from other manufacturers, and that's without all of the Challenger's features.

90588 **99.00**

BREECH LOCK BUSHINGS 2-PACK
Breech lock bushings fit all Lee Breech Lock presses. Allows instant, accurate die changes.

90600 **10.98**

LEE PRESSES all have compound leverage, which permits full length sizing the largest magnum cases with ease. All have built in spent primer catchers and tough powder coat finish. Individual detailed instructions accompany each press. Make your selection according to need — based on price, speed and convenience. For even greater bargains, consider the kits on pages 6 and 7.



CHANGE DIES INSTANTLY WITH A TWIST OF THE WRIST

BIG GUN INSPIRED BREECH LOCK QUICK CHANGE is now standard on most Lee single station presses. Switch dies with a 1/6 of a turn rather than fourteen or more turns. Loading with a Breech lock equipped press



is convenient as a Turret press when loading small quantities of ammunition. Interrupted three-start thread assures dies will return and lock into the exact same position. The Breech lock system includes a lock pin to allow easy initial setup. If cost is more important than convenience you can leave the Breech Lock bushing locked in the press and screw dies in and out like a conventional press.

LOCK-RING ELIMINATOR

Breech lock quick change bushing with integral lock collar provides unmatched precision and convenience when adjusting dies. Split clamp positively locks die into position. Perfect when using other brands of dies in your Breech lock press.

90063 2-PACK

16.00



Lee Reloader Press

An outstanding value. Exclusive balanced lever that can't drop down to pinch your fingers. Unlimited hand clearance that only a "C" frame can offer. Works equally well with the right or left hand. Even if you already own a press, an extra press is always useful for decapping, bullet seating or bullet sizing.

90045 **39.98**

Lee Breech Lock Hand Press

Now with the Lee Breech Lock System! A full size hand held reloading press, yet the tool weighs only 1¾ pounds and costs so little you will want more than one. No matter how much equipment you have, it's great to have a portable hand press. No time is wasted mounting a tool to a work bench. When you're finished—just pack it away.

90685 **49.00**



PRIMING ON THE PRESS HAS NEVER BEEN MORE CONVENIENT

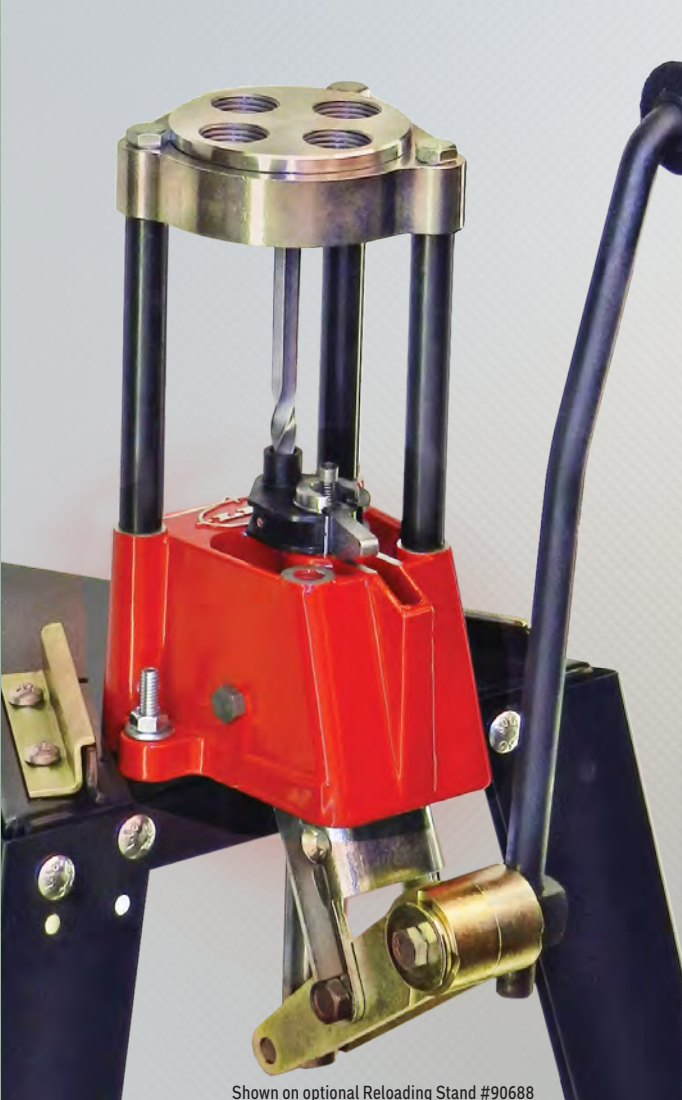

Shown on optional Reloading Stand #90688

TURRET PRESS

Equipped with the Lee Lever Prime System.™

Proven design with compound leverage. No spring in this turret design. The turret is locked into a solid steel ring with big rifle bolt type lugs. Exclusive design puts the lugs on the circumference so there can be no tipping. The linkage is so powerful that the largest magnum cases are sized with ease. Effort required is so small that the usual heavy bench is not essential. The Lee Turret Press has built-in primer catcher and a comfortable roller handle. Even if you do not need all of these features, why pay more for anything less?

4 HOLE TURRET PRESS W/AUTO INDEX 90932 125.00

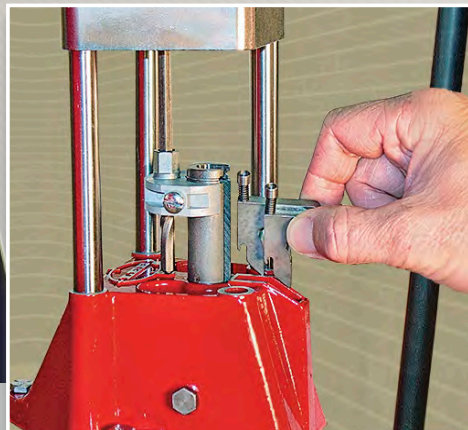

Power and strength to spare, plus unequalled convenience. The LEE TURRET PRESS is suitable for loading all rifle and pistol cases, but really shines when loading large quantities of handgun ammunition. This is the most convenient press made. Only a true progressive press is faster. Includes the LEE LEVER PRIME SYSTEM with large and small primer arms. Features lift out convenience. Works with the LEE SAFETY PRIME.

Lee Safety Prime

Makes priming on the press a delight. Never touch the primers from box to shell. Primer flip tray features a CAD designed flipping surface that instantly rights the primers. Change primer size in seconds. Primers are dispensed with a satisfying click of the primer feed trigger.

90997 30.00

90041 AUTO-DISK RISER FOR SAFETY PRIME



UPDATE KIT FOR PRE-2006 PRESSES 90042 53.00

Everything required to add primer feed - includes both LARGE AND SMALL SAFETY PRIMER FEED

This is the best buy in reloading presses!

GET AN ADDITIONAL TURRET FOR YOUR LEE PRESSES



WHY FOOL AROUND WITH A SINGLE STATION PRESS screwing dies in and out two and three times for each caliber? No longer is it necessary to use the batch system for reloading. Now you can load a complete round with several strokes. Those who want the utmost in convenience can purchase extra turrets and never remove the dies. Simply lift out the entire turret and replace with the next caliber. Dies, shell holders and primer arm can be changed in seconds without tools.



EXTRA TURRET, 4 HOLE 90269 15.00



This is the press you have been asking for. Based on the proven design of the Classic Cast, the new Breech Lock series adds the quick-change die bushing.

Breech Lock Classic Cast Press

Rigid cast iron construction with all steel linkage. Durable powder coated finish with largest opening and the longest stroke in the industry.

Adjustable handle from right to left and length. Swing position is fully adjustable with a 48-tooth ratchet type handle clamp.

LEE BREECH LOCK CLASSIC CAST 90999 **170.00**

The industry's largest 1 1/8" diameter ram supported by over 12 square inches of ram bearing surface.

Built-in primer catcher with tube for direct trash disposal.

LEE LEVER PRIME SYSTEM features bottom of stroke priming for unmatched sensitivity.

Includes both large and small priming arms No need to fumble with tiny guides and springs when changing primer size.

Frame machined to accept Lee quick-change Breech Lock Die bushings. Change dies instantly with a quick 1/8 turn.

Breech Lock Classic Cast Press Kit

If you are getting started or moving up to the best, this kit is for you. The kit is built around the rigid, cast iron Lee Breech Lock Classic Cast Press with Quick Change Breech Lock Quick Change Bushing.

The kit also includes the new Lee Classic Cast Powder Measure and the new universal powder measure stand. Complete case preparation tools including the Deluxe Quick Trim Case Trimmer, primer pocket cleaner, chamfer tool, and cutter and lock stud for the Lee Case Length Gauge trimming system.

Check your loads with the included Lee Safety Powder Scale.

Priming is accomplished with the Lee Ergo-Prime tool. The kit includes a complete set of shell holders for hundreds of cartridges.

The kit is completed with Lee Modern Reloading. The complete guide to reloading featuring 167 cartridges with over 28,000 loads. This kit and a set of Lee dies gives you everything you need to setup the finest reloading system. Purchased separately, would cost nearly \$485.00

LEE BREECH LOCK CLASSIC CAST PRESS KIT 90455 **380.00**



Lee Classic Cast Press

The largest opening in the industry and the longest stroke — yet handle is adjustable to provide the least travel of any press.

Rigid cast iron construction in a classic "O" design for maximum strength. Baked powder coating is durable and makes the Classic Cast a handsome addition to any reloading bench.

Large, flat cored base with 3 mounting holes mounts solid to any bench.

Adjustable handle is movable from right to left. Start and stop position is adjustable with a 48-tooth ratchet type handle clamp. In addition, the handle length is completely adjustable. Shorten it when loading handgun and short rifle cases.

Automatic primer arm with bottom of stroke priming for best feel. Includes two primer arms for large and small primers.

No more fumbling with tiny guides and springs.

The original Classic Cast designed to work with large series 1 1/4–12 dies. Includes threaded adapter to accept standard 7/8–14 dies.

Large 1 1/8" diameter ram is drilled completely through to allow spent primer disposal direct to trash can with attached tube. Ram is two piece to allow installation of the mammoth 50 BMG shell holder. All supported by over 12 square inches of ram bearing surface.

Powerful compound linkage with positive travel stop prevents press toggle or "cam over."

Accepts standard shell holders, ram insert can be rotated to allow primer installation on right or left side.

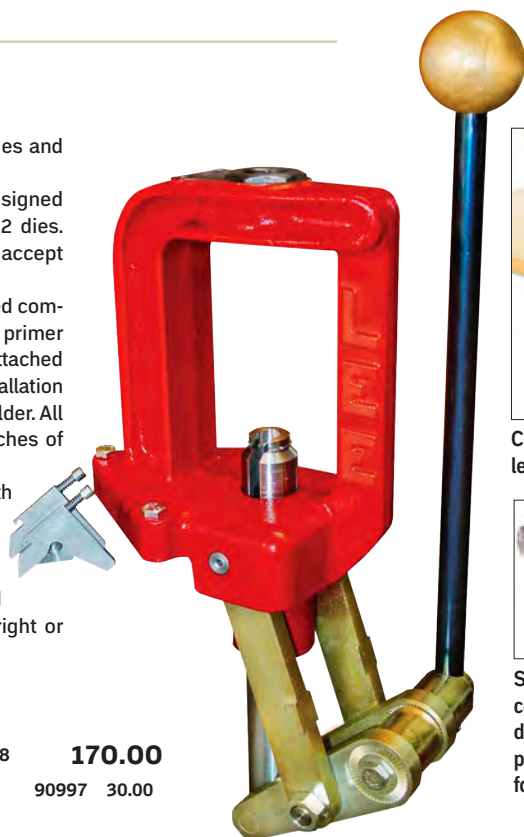

Changes easily for left-handed use.



Spent primers collected and dropped into a flexible plastic tube for easy emptying.



LEE CLASSIC CAST PRESS 90998 **170.00**

LARGE & SMALL PRIMER FEEDER 90997 30.00

CLASSIC CAST SERIES PRESSES

Rigid cast iron frame—cast and machined with pride in the USA, baked powder finish and all steel linkage make the Lee Classic Cast Series presses some of the most attractive and sturdy presses made.

A machine that does it all This press has all the features of the award-winning Turret Press with quality touches that make this the finest, most convenient press to own. The Classic Turret features the solid steel linkage of the Lee Classic Cast. Your first stroke of the hardwood gripped lever will convince you this is one solid, silky smooth press!

Lee Classic Turret Press

The sturdy iron base shows its Classic Cast roots. The long stroke allows rifle cases over three inches long to be loaded using the automatic index. Deactivate the Auto-Index and cases over 4 inches can be loaded. The rigid cast iron frame supports the ram with over 12 square inches of area. The industry's largest ram is drilled completely through to dispose primers in an attached clear PVC tube. Every primer is caught — guaranteed.

Instant change turrets are the same as the famous Lee Turret Press. The Classic Turret uses the new LEE LEVER PRIME SYSTEM · LPS and the Lee Safety Prime tool makes priming on the press a delight. If you like to own the best, then treat yourself to the Lee Classic Turret. The finest reloading system made.

LEE CLASSIC TURRET PRESS 90064 **163.00**



LEE SAFETY PRIME

Makes priming on the press a delight. Never touch the primers from box to shell. Primer flip tray features a CAD designed flipping surface that instantly rights the primers. Change primer size in seconds. Primers are dispensed with a satisfying click of the primer feed trigger.

LARGE & SMALL PRIMER FEEDER

90997 **30.00**

90041 AUTO-DISK RISER FOR SAFETY PRIME

Lee Classic Cast 50 Caliber BMG Press Kit



50 BMG DIE SET 1¼-12 THREAD
90515 **125.00**



At last, an affordable way to reload the monster 50BMG. Kit includes everything you need to start reloading the 50 —the Lee Classic Cast press, set of 50 BMG dies, shell holder, ram prime tool and tube of case sizing lube.

Kit also includes shell holder insert, large and small primer arms and die reducer bushing to accept standard 7/8-14 dies so you can load all your smaller cartridges. All this for less than what others charge for dies alone.

50 CALIBER BMG PRESS KIT

90859 **370.00**



50 BMG RAM PRIME TOOL
90901 **25.00**



50 BMG FACTORY CRIMP DIE
90953 **50.00**
50 BMG SHELL HOLDER
90903 **20.00**



Fully automatic

Lee Pro1000

Add a bullet and pull the lever; all other operations are automatic. One loaded cartridge with each pull of the lever. Every operation is automatic. Primers, like the powder, are fed only if a case is present. No wasted primers or spilled powder. Alternate loading sequence lets you load only one case at a time. Makes learning easy for the first time user and great for fine adjustments or experimenting. You can start reloading good ammunition minutes after the press is bolted down. Change calibers in just three minutes.

MAXIMUM CARTRIDGE LENGTH 2 5/16"

32 S&W LONG and 32 H&R MAG	90639*
380 AUTO	90641*
38 SPECIAL	90636
Can use for 357 Magnum	
357 MAGNUM	90637
38 AUTO and 38 SUPER	90035
9mm LUGER	90640
40 S&W	90682
10mm AUTO	90632
41 MAGNUM	90642
44 SPECIAL	90634
can use for 44 Magnum	
44 MAGNUM	90635
45 ACP	90638
45 COLT	90643
223	90633
Includes Rifle Charging Die. Not available in carbide	

*Limited loads available for automatic powder measure

**LEE PRO 1000
COMPLETE READY TO RELOAD
280.00**

Safe with CC1 or REMINGTON brand primers only



Shown on optional Reloading Stand #90688 & Bin and Bracket #90687

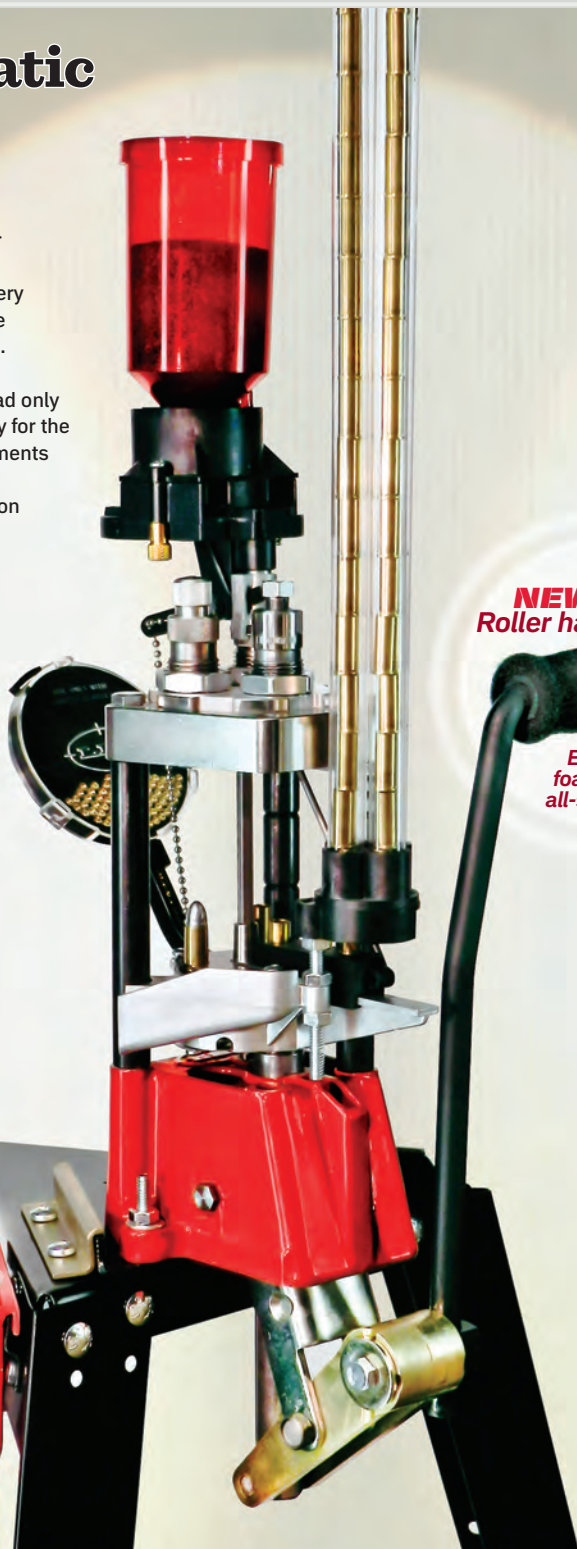

**SHELL PLATES
20.00**

SHELL PLATE #1	90651	38 SPL, 357 MAG., etc.
SHELL PLATE #2	90652	45 ACP, etc. 45 GAP
SHELL PLATE #3	90664	45 WINCHESTER MAGNUM
SHELL PLATE #4	90653	222, 223, 380 AUTO, 32 S&W LONG 32 H&R MAGNUM
SHELL PLATE #6	90976	32/20, 25/20
SHELL PLATE #7	90655	30M1 CARBINE, 32 AUTO
SHELL PLATE #9	90656	41 MAGNUM
SHELL PLATE #11	90657	44 SPECIAL, 44 MAG, 45 COLT
SHELL PLATE #12	90666	7.62x39, PPC, 220 RUSSIAN
SHELL PLATE #13	90665	45 AUTO RIM
SHELL PLATE #14	90065	38/40, 44/40, 45 COLT, 460 S&W
SHELL PLATE #19	90669	40 S&W, 10mm AUTO, 9mm LUGER 38 SUPER, 38 AUTO, 41 AE

**NEW
Roller handle**



*Ergonomic
foam grip and
all-steel linkage*

If you order Shell Plates to convert to another caliber with a different primer size, be sure to order the Pro 1000 Primer Attachment.

**PRO 1000
PRIMER ATTACHMENT
90660 15.00**



SHELL PLATE CARRIER 55.98

To change calibers, the entire Shell Plate Carrier can be replaced. Each unit comes complete with Shell Plate, Auto Prime, Case Ejector, Auto-Index and spare parts.

CARRIER COMPLETE WITH SHELL PLATE AND PRIMER FEEDER

#1 Carrier	90644	38 SPL, 357 MAG, etc
#2 Carrier	90645	45 ACP, etc.
#4 Carrier	90646	222, 223, 380 AUTO, 32S&W LONG, 32H&R MAG
#6 Carrier	90647	32/20, 25/20
#7 Carrier	90648	30 M1 CARBINE, 32 AUTO
#9 Carrier	90649	41 MAGNUM
#11 Carrier	90650	44 SPECIAL, 44 MAGNUM, 45 COLT
#19 Carrier	90683	40S&W, 9mm LUGER, 38 SUPER, 38 AUTO, 41AE
#19L Carrier	90662	10mm AUTO



**TURRET
90497 15.00**

ACCESSORIES FOR PRO 1000 and LOAD MASTER PRESSES

CASE FEEDER

LARGE CASE FEEDER	90658	25.00
38 SPECIAL • 357 MAGNUM • 41 MAGNUM 44 SPECIAL • 44 MAGNUM • 45 ACP 45 COLT • 10mm AUTO • 7.62x39 RUSSIAN 40 S&W uses the Large Case Feeder with a small slider.		
SMALL CASE FEEDER	90659	25.00
9mm LUGER • 380 AUTO • 32 AUTO 32 S&W LONG • 32 H&R MAGNUM • 38 AUTO 38 SUPER		
RIFLE CASE FEEDER	90663	25.00
222 • 223 • 30 M1		
EXTRA CASE FEEDER TUBES 7-PK.	90661	7.98

ADJUSTABLE CHARGE BAR 90792 9.98
SEE PAGE 17

CASE COLLATOR

Fills all four tubes in just ten seconds.
For the Pro1000 or Load-Master
90667 14.98

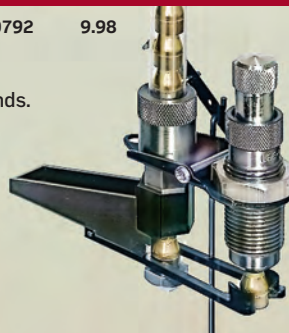

BULLET FEED KIT

The bullet feeder designed to directly fit the Pro1000 and Load-Master. Automatically feeds bullets into the mouth of the seating die. Aligns bullets more accurately than possible by hand. Increases the cyclic rate 50 to 100%.

Order from chart at right **48.00**

Finest reloader made

Lee Load-Master

- A massive press with advanced features.**
 - Ram is 1 3/4 inches in diameter.**
 - Stroke and clearance sufficient for largest magnum rifle cases.**
 - Load rifle and pistol rounds with equal ease.**
 - Load progressively or singly without spilled powder or components.**
 - Five stations so you can factory crimp and post size.**
 - Accepts all popular brands of dies • 7/8 x 14**
 - Automatic indexing with a wedge lock mechanism that will actually hold a ton.**
 - Positive and foolproof priming system that is easy and fast to fill.**
 - Removable turrets.**
 - Change calibers in seconds.**
 - Automatic 4 tube case feeder (pistol calibers)**
 - Loaded round ejector and case catcher.**
 - Quick change shell plate.**
 - No tools required.**
 - Grease fittings along with hard chrome plated ram insure a lifetime of service for even the commercial reloader.**
 - Easy to empty primer catcher guaranteed to catch every primer.**
- This press will convince you that Lee is the quality leader. Every part of this tool was designed to be strong, long lasting, rust-resistant and user friendly. This machine is designed for a life-time of the hardest use.



Precision 5-Hole Turret with 20 locking lugs takes just seconds to change.
90079 16.00

48.00	Description	14.98
Feed kits complete		Feed die and fingers
90892	30 & 32 cal Bullets up to .60 long	90885
90893	9mm through .365 diameter up to .46 long	90886
90894	9mm through .365 diameter .46 to .60 long	90887
90895	9mm through .365 diameter .60 to .75 long	90888
90896	40 cal through .44 cal up to .65 long	90889
90897	40 cal through .44 cal .65 to .80 long	90890
90898	45 cal bullets .50 to .67 long	90891

The **BULLET FEED KIT** is complete for one bullet diameter and range of length. To convert to another caliber or bullet length select appropriate FEED DIE AND FINGER.

MULTI-TUBE ADAPTER FOR BULLET FEED KIT

Four tube magazine keeps Lee Bullet Feeder fed with a continuous supply of bullets. Quickly and easily installed. Includes large and small adapters, four large and small feed tubes and cylinder, plate assembly.
90280 **25.00**

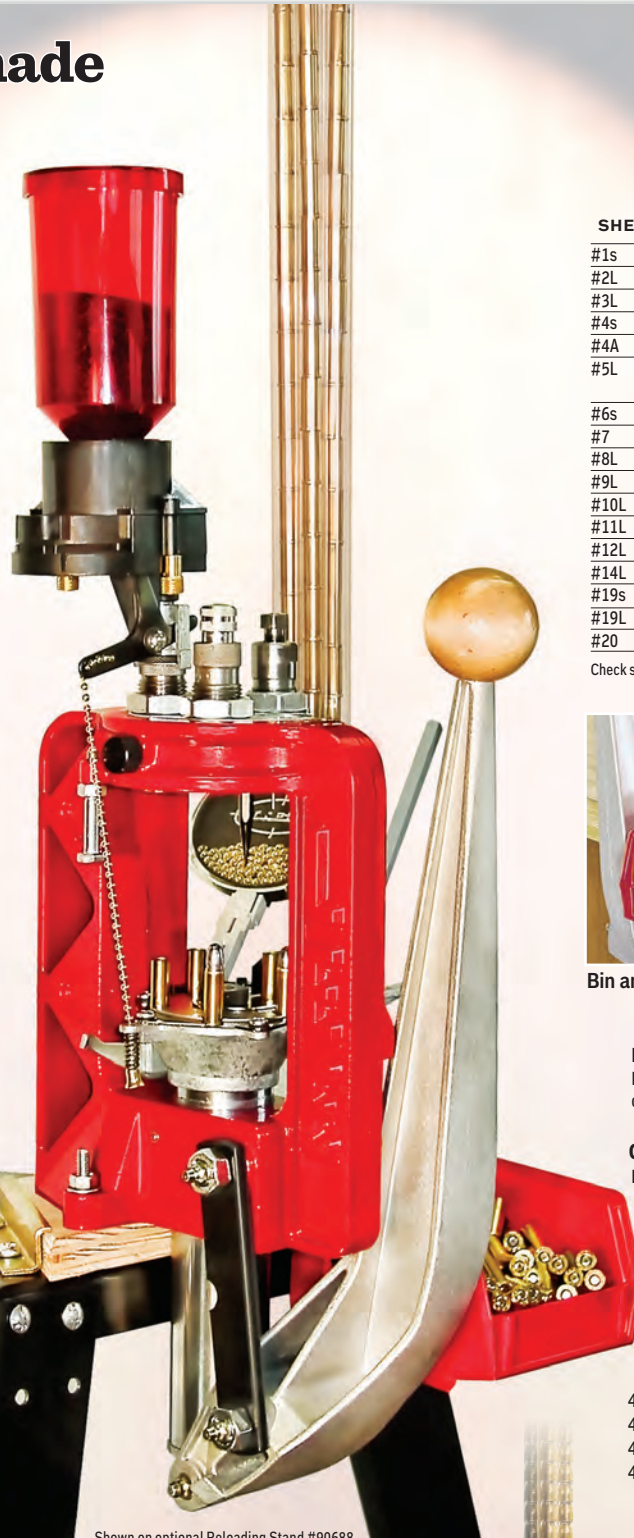

Shown on optional Reloading Stand #90688

SHELL PLATE 29.98

#1s	90907	38 Spl, 357 Mag., etc.
#2L	90908	45 ACP, 30/06, 308, etc.
#3L	90909	30/30, 7x30 Waters, etc.
#4s	90910	223, 222, etc.
#4A	90059	32 S&W Long, 32 H&R Mag., etc.
#5L	90911	Belted Magnums 300 Mag, etc. 303 British & 30/40 Krag
#6s	90912	32/20, 25/20 etc.
#7	90913	30 M1 Carbine, 32 ACP
#8L	90914	45/70, 348 Win.
#9L	90915	41 Magnum
#10L	90916	220 Swift, 6.5 Jap.
#11L	90917	44 Mag., 44 Spl., 45 Colt
#12L	90918	7.62x39, 6mm PPC, 22 PPC, etc.
#14L	90919	44/40, 38/40, 45 Colt, 460 S&W
#19s	90920	9mm Luger, 40 S&W, 38 Super, etc.
#19L	90068	10mm Auto
#20	90884	22 Hornet

Check shell holder chart on page 16 for further listings.



Bin and Bracket included

Order additional #90687

Explosion Shield 90363 6.00

Necessary if using primers other than CCI or Remington brand

CALIBERS are equipped with Reloading Dies, Pro Auto-Disk Powder Measure and a case feeder 384.00

223 Remington	90922
32 S&W Long • 32 H&R Mag	90935*
9mm Luger	90936
380 Auto	90937*
38 Spec. (will load 357 Mag.)	90938
40 S&W	90940
10mm Auto	90941
44 Spec. (will load 44 Mag)	90943
44 Magnum	90944
45 ACP	90945
45 Colt (will load 454 Casull)	90946

*Limited loads available for Automatic Powder Measure

Special sizes can be made with any die set listed in this catalog for the same prices listed above.

LARGE PRIMER FEEDER

90077 24.98

SMALL PRIMER FEEDER

90075 24.98



FOR SAFETY SAKE, TRIM YOUR CASES

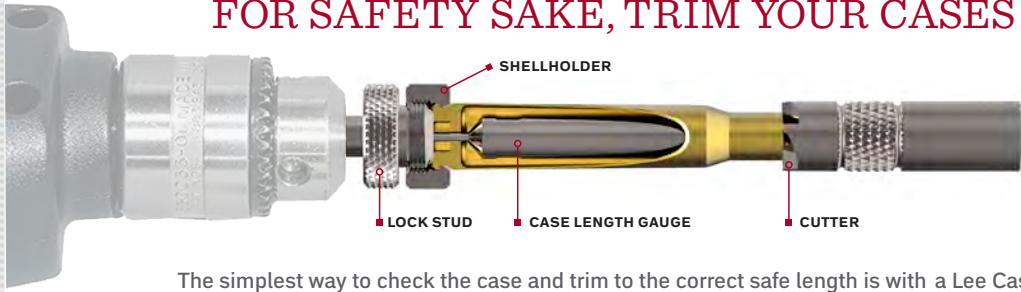

The simplest way to check the case and trim to the correct safe length is with a Lee Case Trimmer.

Lee Case Trimmer

After a case has been loaded a few times, it will stretch beyond maximum length and must be trimmed. There is no better system to check and trim cases than with the Lee Case Length Gauge and cutter. You don't need an expensive caliper to set length and never waste even a single case setting up with the cut and try system common to all other brands. The piloted cutter assures the case mouths are absolutely square and true

to the case neck. Best of all, the fixed length design assures it will never go out of adjustment.

The CUTTER and LOCK STUD works for all calibers. You will need only one. The CASE LENGTH GAUGE (PILOT) and SHELL HOLDER must be ordered as CASE LENGTH GAUGE and SHELL HOLDER for each caliber—see size listing at right). You can trim cases by hand, use an electric drill or the LEE ZIP TRIM.

CUTTER AND LOCK STUD 90110

LARGE CUTTER & LOCK STUD 90401
For .475 and larger cases. Can be used on any case.

LARGE CUTTER ONLY 90468

Large cutter with 8–32 thread shank for use on popular powered case preparation centers.



6.98

9.98

9.98

CUTTER ONLY WITH BALL GRIP 90275



9.98



PRIMER POCKET CLEANER Double ended design cleans both large and small primer pockets. Primers can be fully seated for better accuracy and safety. Costs so little and works so well, no reloader can afford to be without one.

90101

2.98

CASE CONDITIONING KIT Includes cutter and lock stud, chamfer tool and primer pocket cleaner.

90950

12.98

CHAMFER TOOL Must be used after Case Trimming. Unique design cuts fast without chatter. One turn does the job. Chamfers and deburrs inside and outside of case necks. Can also be used to remove the crimp from primer pockets of G.I. brass. Works better than tools costing several times as much.

90109

3.98



The Zip Trim rotates your case like a lathe. While your case is mounted, you can quickly trim, chamfer and polish your case. The Zip Trim's hardened steel spindle accepts the case length gauge shell holder or has two permanent mounting lugs and a socket to accept a "C" clamp for a completely portable set-up.

90899

25.98

ZipTrim Power Head



3 JAW CHUCK

Works with any case from 25 ACP to the largest belted magnums. Three hardened steel jaws gently center the case while the spindle locks the case head. Cases are installed and removed with a fraction of a turn. For use with Spinner Stud (90607) or Zip Trim (90899)

90608

17.98



CASE SPINNER STUD

Optional case spinner spindle with drill shank for use with the 3 Jaw Chuck, turns any electric drill into a high speed case polisher/lathe. Also works great to hold cases for neck turning or trimming.

90607

3.98



:03 Trim case using the Lee Case Trimmer

:03 Chamfer the case inside and out

:06 Polish case with steel wool or "scotch-brite"

Polishing the cases with steel wool or plastic scouring pad is so much faster than case tumbling. No time is required separating the cleaning media from cases, so no worry of the media sticking to the inside of your cases and no digging the media out of the flash hole.

:12 seconds to a finished case

Case Length Gauge

CARTRIDGE

CASE LENGTH GAUGE & Shellholder
5.98*

22 Hornet	90111
218 Bee	90225
221 Fireball	90112
222 Remington	90113
223 Remington	90114
223 WSSM	90673
22/250	90116
220 Swift	90118
243 Winchester	90119
243 WSSM	90389
6mm Rem (244 Rem.)	90120
25/20 W.C.F.	90121
250 Savage (250/3000)	90122
257 Roberts	90123
25/06 Remington	90124
6.5 Carcano	90043
6.5 Remington Mag	90791
6.5 x 55 Mauser	90126
6.5 Creedmoor	90814
260 Remington	90993
6.8 SPC	90189
270 Winchester	90128
270 Winchester Short Mag	90117
284 Winchester	90129
7 x 57 Mauser	90130
7mm/08	90167
7mm Express/280 Rem.	90166
7mm Remington Magnum	90131
7mm Win Short Mag	90314
7 x 64 Brenneke	90236
7.5 Swiss (Schmidt-Rubin)	90132
7.5 x 54 MAS	90051
7.62 x 39 Russian	90133
7.62 x 54 Russian	90147
7.65 Mauser (Belgian-Arg)	90134
30 M1 Carbine	90135
30/30 Winchester	90136
30/40 Krag	90137
300 Savage	90138
300 AAC Blackout	90443
300 Winchester Short Mag	90034
308 Winchester	90139
30/06 Springfield	90140
300 H&H or Ultra Mag	90141
300 Winchester Magnum	90142
300 Weatherby Magnum	90143
303 British	90144
32/20 W.C.F.	90146
7.7 Japanese	90115
8x56 Aust-Hung Mannlicher	90589
8 x 57 Mauser	90148
325 WSM	90222
338 Lapua	90462
338 Winchester Magnum	90149
35 Remington	90150
35 Whelen	90972
375 Winchester	90165
375 H&H or Ultra Mag	90164
444 Marlin	90151
450 Marlin	90554
45/70 Government	90152
458 Winchester Magnum	90971
32 Smith & Wesson Long	90169
32 Winchester Special	90491
9mm Makarov	90684
9mm Luger	90153
38 Super	90217
380 Auto	90155
38 Smith&Wesson	90156
38 Special	90157
38-55	90994
357 Magnum	90158
40 S & W	90154
10mm Auto	90127
41 Magnum	90159
44/40	90168
44 Special	90160
44 Magnum	90161
45 ACP	90162
45 Colt	90163
454 Casull	90992
45 Gap	90224
460 S & W	90220
480 Ruger	Requires Large Cutter 90018
500 S & W	Requires Large Cutter 90019
50 BMG	Requires Large Cutter 90010 20.00

* Unlisted case length gauges can be custom-made for \$15 plus s&h. Available factory direct only if case head fits existing shell holder.



DECAPPER & BASE Easily removes crimped in primers from military cases. Guaranteed unbreakable.

22 CALIBER 90103
30 CALIBER 90102 **7.98**



DECAPPING DIE

An absolute must for those who clean cases before reloading. Cases need not be clean nor lubed when using this die. Tough, almost unbreakable decapper easily removes crimped in primers. Fits cases up to .560" in diameter and up to 3.125" long.

90292 **14.98**

REPLACEMENT DECAPPER
90783 3.00



UNIVERSAL CASE EXPANDING DIE

Gently flares the case mouth to accept cast bullets without shaving. Works great to prevent damaging the moly and low friction coatings found on today's high performance jacketed bullets. Includes neck plugs for .22 cal through .45 cal. Works on everything from the 22 Hornet to the largest Ultra Mag.

90798 **16.98**

QUICK TRIM

Trim brass to correct length while chamfering the case mouth

Lee Deluxe Quick Trim Case Trimmer

The Deluxe Quick Trim Case Trimmer quickly and precisely trims your brass to the correct length at the same time it chamfers the inside and outside of the case mouth. No calipers, measurement or adjustment required. Simply install the appropriate quick trim die in your press and start trimming. A click adjustable stop allows trim length adjustment in .001 of an inch increments. Allows the user to shorten case to a uniform shorter length than standard, reducing trimming frequency. Includes snap on chip catcher.

90437 **26.00**



LEE VALUE TRIM

90386 13.98

Same quick trimming and click adjustability as the deluxe version, but doesn't include the inside/outside chamfer blades and we skipped the fancy chrome plating.

DELUXE CUTTER ASSEMBLY

90355 12.00

Update your Value Trim adding automatic case chamfering or use to replace a dulled cutter.



RIFLE CARTRIDGE	QUICK TRIM DIE BODY 10.98▶	RIFLE CARTRIDGE	QUICK TRIM DIE BODY 10.98▶	PISTOL CARTRIDGE	QUICK TRIM DIE BODY 14.98▶
17 Rem	90435	7.5 Swiss (Schmidt-Rubin)	90419	9mm Makarov	90181
204 Ruger	90439	7.62 x 39 Russian	90345	9mm Luger	90032
22 Hornet	90354	7.62 x 54 Russian	90342	380 Auto	90025
222 Remington	90340	30 M1 Carbine	90365	38 Special	90085
223 Remington	90179	30/30 Winchester	90249	357 Magnum	90088
22/250	90284	300 AAC Blackout	90689	40 S & W	90033
243 Winchester	90320	300 Winchester Short Mag	90484	10mm Auto	90193
6mm Remington (244 Rem.)	90434	308 Winchester	90231	41 Magnum	90226
25/06 Remington	90334	30/06 Springfield	90291	44 Special	90107
6.5 x 55 Mauser	90337	300 H&H	90407	44 Magnum	90125
6.5 Creedmoor	90812	300 Winchester Magnum	90441	45 ACP	90073
260 Remington	90399	300 Weatherby Magnum	90408	45 Colt	90145
6.8 SPC	90397	303 British	90325	454 Casull	90174
270 Winchester	90229	8 x 57 Mauser	90347	500 S & W	90178
270 Winchester Short Mag	90393	338 Winchester Magnum	90391		
7 x 57 Mauser	90489	35 Remington	90403		
7mm/08	90343	375 H&H	90395		
7mm Express/280 Rem.	90412				
7mm Remington Magnum	90297				

▶ Unlisted Quick Trim Dies can be custom made for \$25.00 plus s&h.

The ultimate in Case Trimming Speed and Convenience

Deluxe Power Quick Trim

Trim and chamfer in a matter of seconds. Hex shank snaps in to cordless screwdriver or drill (sold separately) Includes power Quick-Trim adapter, chip catcher and deluxe cutter assembly. To complete your trimming setup, order cartridge specific pistol or rifle Quick Trim die from list above.

90670 **26.00**

Power Quick Trim Stud

Motorize your Quick Trim

The Power Quick Trim adapter stud enable you to motorize your Value or Deluxe Quick Trim. Hex shank snaps in to any inexpensive cordless screwdriver (sold separately). This tool also requires a cartridge specific pistol or rifle Quick Trim die.

90740 **14.00**

Cordless screwdriver pictured is not included.

LEE PRIMING TOOLS SHELL HOLDERS



Fastest, most convenient hand held priming tools made. Includes large and small trays sized to fit today's larger primer boxes.

Tray's built in flipping surface quickly rights and orients primers. Clear, slide on cover provided for both trays. Patented elevator pin safely isolates a single primer for priming, eliminating the primer brand restriction on prior tools. Both priming tools use special, but inexpensive shell holders so there's no need to endlessly swap press shell holders to prime. See listing below.

Lee Safety Prime

Makes priming on the press a delight. Never touch the primers from box to shell. Primer flip tray features a CAD designed flipping surface that instantly rights the primers. Change primer size in seconds. Primers are dispensed with a satisfying click of the primer feed trigger.

LARGE & SMALL 90997 **30.00**

Auto Prime XR

The original and world's most popular hand held priming tool. Fast and economical hand held priming with unmatched feel and accuracy.

90230 **26.98**



Lee Ergo Prime

Premium hand held priming tool with all the features of the world's most popular Auto-Prime, with a new ERGO nomic design. The Ergo Prime's highly sculpted body fits your hand perfectly, along with a long smoothly contoured finger lever that easily installs the tightest primers. Fingertip operation provides unmatched sensitivity and comfort, especially for older hands. Change primer size in an instant—no tools or disassembly required, simply remove shellholder and swap primer trays. Powder coated metal body and polished chrome plated lever makes the Ergo-Prime not only the most comfortable, but also the best looking tool made.

90250 **49.00**

Two great ways to prime



Lee Ram Prime

Primes on the press up-stroke for a more sensitive feel. Includes easy to change punches for both large and small primers. Fits all brands of presses. Same tool as supplied with the Hand Press Kit.

90106 **14.98**



SHELL HOLDERS

FOR AUTO-PRIME XR ERGO PRIME **2.98** FOR PRESSES **3.98**

#1	90201	90518
#2	90202	90519
#3	90203	90520
#4	90204	90521
#5	90205	90522
#6	90206	90523
#7	90207	90524
#8	90208	90525
#9	90209	90526
#10	90210	90527
#11	90211	90528
#12	90212	90529
#13	90213	90199
#14	90272	90001
#15	90017	90002
#16	90200	90003
#17	N/A	SD2827
#18	N/A	SD2980
#19	90023	90004
#20	90020	SD3590
#21	90031	SD3391
#22	N/A	SD2396
#23	N/A	SD2700
#24	SH2110	SD1874
#25	SH2426	SD1351



Packed in a lifetime plastic box



Set of Shellholders

Eleven of the most popular sizes fit over 115 different cartridges. The chart (at right) is included with each shell holder set.

#1 · 2 · 3 · 4 · 5 · 7 · 8 · 9 · 10 · 11 · 19

RED STORAGE BOX ONLY **90196 4.98**

RED STORAGE BOX **90198 21.98**

with 11 Shellholders for Lee Auto Prime XR & Ergo Prime

GREEN STORAGE BOX **90197 36.98**

with Universal Shellholders that work with all brands of presses

NOTE: WHERE TWO NUMBERS ARE MARKED, THE FIRST NUMBER IS THE BETTER CHOICE.

HOLDER	RIFLE	HOLDER	RIFLE	HOLDER	RIFLE
4	17 Remington	5	7mm Rem. Magnum	14	38/40 Win.
4	204 Ruger	5	7mm Win S Mag	3	38/55 Winchester
20	22 Hornet	5	7mm Weatherby	8	40/82 Winchester
20	22 K Hornet	5	7mm Ultra Mag	5	416 Remington
3	22 Savage	2	284 Winchester	25	416 Rigby
2	22 BR	3	7.5mm Schmidt-Rubin	18	43 Mauser
6	218 Bee	7	30 M 1 Carbine	17	43 Spanish
12	22 PPC	3	7.65x53 Arg. Mauser	14	44/40
3	219 Zipper	12	7.62mm x 39	11	444 Marlin
10	220 Swift	16	7.62x54 Russian	8	45/70 Gov't
4	221 Fireball	3	30 Herrett	5	458 Win. Magnum
4	222 Remington	3	30/30 Win. (30 W.C.F.)		HOLDER PISTOL
4	222 Rem. Magnum	2	300 Savage	15	5.7 x 28
4	223 (5.56mm)	16	30/378	1	22 Rem. Jet
5	223 WSSM	21	30 Remington	15	25 ACP
2	224 Clark (22/257)	2	308 Win. (7.62 NATO)	1	256 Win. Magnum
10	225 Winchester	4	300 AAC Blackout	19	30 Luger
2	22/250	5	30/40 Krag (30 U.S.)	19	30 Mauser
2	240 Weatherby	2	30/06 Springfield	4	32 Short Colt
2	243 Win.	5	300 H & H	4	32 S & W
5	243 WSSM	5	300 Weatherby	4	32 S & W Long
2	6mm Remington	5	300 Win. Magnum	4	32 S & W
2	244 Remington	5	300 Ultra Magnum	7	32 ACP
2	6mm Int'l	5	300 Win S Magnum	4	32 Colt N.P.
2	6mm/284	5	308 Norma Magnum	4	380 Auto
2	6mm/06	5	303 British	19	9mm LUGER
12	6 PPC	2	7.7 Japanese	1	38 S & W
4	6 x 47 (6mm/222M)	3	32 Win. Spc'l	1	38 Colt N.P.
2	25/284	3	32 Win. S.L.	19	38 Super Auto
2	25/06	6	32/20 (32 W.C.F.)	19	38 ACP
6	25/20 Winchester	3	32/40 Winchester	1	38 Short Colt
2	250 Savage	2	8 x 57 Mauser	1	38 Long Colt
3	25/35	2	8mm 06	1	38 Special · 357 Mag
2	257 Roberts	2	8mm Man. Schoe.	19	357 Sig
5	257 Weatherby	5	8mm Rem. Magnum	2	357 Auto Magnum
5	303/25	17	8mm Lebel	19	40 S&W · 10mm Auto
2	6.5mm 06	16	8x56R Hungarian	1	41 Long Colt
2	6.5mm x 57	8	33 Winchester	19	41 Action Express
3	6.5 x 55 Mauser	25	338 Lupa	9	41 Magnum
10	6.5 Jap	5	338 Win. Magnum	11	44 S&W Spl. 44 Mag
5	6.5 Rem. Magnum	5	338 Ultra Magnum	11	44 S & W Russian
2	6.5 Carcano	5	340 Weatherby	2	44 Auto Mag.
12	6.5 Grendel	8	348 Win.	2	45 Auto
5	264 Win. Magnum	2	35 Remington	11+14	45 Colt
21	6.8 SPC	5	35 Winchester	11	454 Casull
2	270 Winchester	2	35 Whelen	14	460 S&W
5	270 Weatherby	5	350 Rem. Mag.	5	455 Webley
5	270 Win S Mag	3	356 Winchester	13	45 Auto Rim
2	280 Remington	2	358 Winchester	3	45 Win. Magnum
2	7mm/08	5	358 Norma Magnum	5+16	480 Ruger
2	7mm BR	3	375 Winchester	5	475 Linebaugh
4	7mm TCU	5	375 H & H	16	500 S&W
3	7 x 30 Waters	5	375 Weatherby		
2	7 x 57mm Mauser	5	375 Ultra Magnum		
5	7 x 61 Sharpe & Hart				

Charge cases while expanding the case mouth

LEE AUTO-DISK POWDER MEASURE

Auto-Disk Powder Measures automatically dispense charges more uniformly than any other powder measure. The case itself actuates the measure as neck is being flared. Measure is actuated during the presses maximum mechanical advantage. This assures the smooth, even action of the measure. Built-in baffle and precisely molded, glass reinforced charge disks contribute to the unmatched charge uniformity. LEE AUTO-DISK POWDER MEASURE includes all four disks

90578 **35.98**



LEE PRO AUTO-DISK POWDER MEASURE

Commercial reloaders or competitive shooters first choice! Elastomer wiper and teflon coated metal casting make this the smoothest operating measure. Will not cut powder and almost totally eliminates leakage. Large hopper with shut-off valve is attached with brass thumb nuts for the ultimate in disk changing convenience. Increased safety with positive pull-back lever. Includes swivel adapter and spring return lever with spring. LEE PRO AUTO-DISK POWDER MEASURE with all four disks

90429 **53.00**



DOUBLE DISK KIT (NOT PICTURED)

This kit raises the hopper so you can stack two disks. This not only doubles the capacity of the disks but it makes very fine adjustments possible. Most powders can be adjusted up or down .1 grain with different combinations of disks. Complete listing of combinations, 4 extra disks, screws and risers are included.

LEE DOUBLE DISK KIT 90195 **14.98**



Every one of these measures comes with a complete set of four disks. Each disk has six cavities so you get 24 cavities in all. The chart included on the rear of the instruction sheet lists the capacity of each cavity with every type of powder. If you reduce your charge 10% you can safely use this data without weighing your charge.

Fixed cavities are the safest way to meter powder because they can't be misadjusted or get out of adjustment.

AUTO-DISK RISER

Installs between the Lee Powder through Expanding Die and Auto-Disk Powder Measure. Allows convenient use of other brands of dies that have extended adjusting screws and provides clearance for the Lee Safety Prime.

AUTO DISK RISER 90041 **9.98**



LEE RIFLE CHARGING DIE

Die is used to charge small capacity rifle cases using the Auto-Disk Powder Measure. It works the same as the pistol powder through expanding dies except it doesn't expand the case mouth. Rifle case expansion is normally done in the sizing die. Can be used on 22 cal and up to 308 Win.

LEE RIFLE CHARGING DIE 90194 **14.98**



ADJUSTABLE CHARGE BAR

Infinitely adjustable between .28 and 1.6 cc. Lifetime nylon with solid brass, zero backlash micrometer. Easy to set.

ADJUSTABLE CHARGE BAR 90792 **9.98**



PRO AUTO-DISK UPDATE KIT

Update any Lee Auto-Disk Powder Measure with all the PRO features, except for the teflon coating. Includes oversize hopper and valve assembly with elastomer wiper, swivel adapter assembly for fast and easy transfer between die sets, pullback lever, chain and attachments, solid brass knurled thumb nuts. with FREE Adjustable Charge Bar

LEE PRO AUTO-DISK UPDATE KIT 90377 **27.98**



SWIVEL ADAPTER

For fast and easy transfer between die sets. Screws into your die without rotating the measure. Allows precise positioning with firm clamping.

SWIVEL ADAPTER 90477 **6.98**



AVAILABLE EARLY 2015

Auto-Drum Powder Measure

Automatic case actuated drum powder measure. Accurately and automatically dispense powder in your favorite cartridge. Two infinitely adjustable drums included. These Quick Change drums will accurately and reliably drop charges from 1 to 80 grains of powder.

- Case actuated; never spill a charge.
- Exclusive elastomer wiper prevents powder shearing, works great with difficult metering extruded powders.
- Machined body with labyrinth groove mates to the precision molded nylon drums providing a leak free fit with the finest powders.
- Drum is actuated by a steel sector and pinion gear train.
- Quick-change hopper has on/off valve to quickly change powders.
- Sleek modern design, all gears springs and levers inside the die cast housing.
- Same swivel adapter as our famous Pro Auto-Disk powder measure. Makes moving measure fast and convenient.
- Double charge disconnecter reduces the chance of a double charge on progressive presses. (Press must have a fixed tool head or turret to use this feature.)
- Handgun and rifle drums included.



AUTO-DRUM POWDER MEASURE 90811 **TBD**

QUICK CHANGE DRUM SET 90453 **20.00**

Quick change drum set features four precision molded nylon drums. Two small capacity for cases as small as the 25 ACP, adjustable to 223 size rifle cases. Large capacity drums adjustable from 223 case to cases as large as the belted magnums.



Only Lee Dies permit charging the case while expanding the case mouth.

NOTE The Auto-Disk and Auto-Drum Powder Measures must be used with the powder through expanding die supplied with all Lee pistol dies. These dies may be purchased individually. See listing of sizes on pages 22-23.

New The latest addition to the Classic Cast line of reloading tools is the

Lee Classic Powder Measure

No powder measure, regardless of price, has all the features of the Lee Classic Powder Measure.

Rugged Construction

This powder measure features a machined cast iron body—no other material has the heft, stability and rugged appearance that cast iron offers. The precision-machined rotor drum is cast from brass, which is naturally antistatic and spark proof.

Eliminates Cut Powder and Jerky Action

A soft elastomer wiper strikes off the metering chamber rather than cut the powder. You'll be surprised at how smoothly the rotor operates. More importantly, you will enjoy the most uniform of charges.

Easy to Set and Read Micrometer Metering Chamber

Powder charge adjustment is accomplished with a true micrometer adjustable metering chamber. The metering chamber is aluminum with a black anodized finish and features a crisp, permanent, laser engraved scale. The brass micrometer thimble is engraved with .01cc graduations and has a releasable detent lock. With most rifle powders each click is about a 1/10 of a grain, perfect for working up a load.

Changing Powder is Fast and Easy

The Classic Powder Measure features an easily removable hopper with an on/off valve so you can quickly return unused powder to its original container or switch to another type. The hopper feeds to a pre-measuring chamber allowing precise charges regardless of the powder level in the hopper, eliminates the need for an extra powder baffle.

Convenient Mounting

Standard 7/8-14 threaded drop tube mounting shank fits all popular reloading presses. No extra stand or bracket required.

Quick Change Drums

One of the nicest features is the ability to use the new Lee standard quick-change drums (90453). See below. These low cost drums can be preset to your favorite charge and swapped out in seconds.



STAND SOLD SEPARATELY

90868 **95.00** NOTE: PICTURED ON STAND 90587

CLASSIC POWDER MEASURE ACCESSORIES

AVAILABLE MID 2015



A REAL POWDER MEASURE STAND, not a cast or stamped bracket. No need to bolt or screw this beefy stand to your work bench. Heavy powder coated steel stand compliments any brand or color powder measure. Works especially well with other brands of powder measures that don't have Lee's on/off valve or removable hopper feature. When you want to change powders or empty the hopper. Simply lift the stand and you can pour the powder from your measure. When you're finished, store your measure away freeing up valuable bench space.

- Powder coated steel construction**
- 7/8" mounting hole for all popular measures**
- Includes 3 no slip feet**
- Rock solid mount improves measure consistency**
- Space saving freestanding design is portable and convenient.**

POWDER MEASURE STAND 90587 **35.00**



QUICK CHANGE DRUM SET features four precision molded nylon drums. Two small capacity for cases as small as the 25 ACP, adjustable to 223 size rifle cases. Large capacity drums adjustable from 223 case to cases as large as the belted magnums. The large drums include an insert to allow reduced capacity charging like the smaller drum.

All drums are infinitely adjustable within range. No tools required for adjustment. A graduated adjustment key is included with each drum. Each turn of the adjusting screw is .1cc or about one grain of powder. Each key is marked with .01cc graduations allowing easy 1/10-grain powder adjustments.

QUICK CHANGE DRUM SET 90453 **20.00**

Lee Safety Scale

Magnetically damped with approach to weight

Safety and accuracy are the most important features

This is the only scale that can never get out of adjustment. The beam is made from a very tough phenolic, the same type material used on table and counter tops. Phenolic is tough but, like glass, it can't be bent. Even if dropped you can feel confident that if it did not break it is still accurate. Sensitive and readable to 1/20 grain.

90681 **35.98**

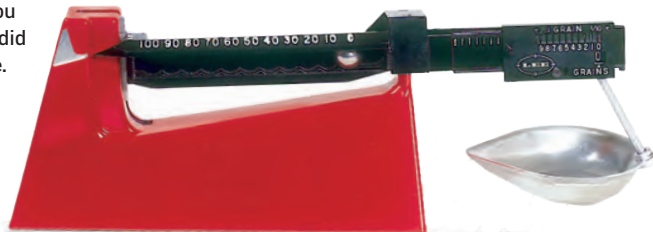

READ THIS IF YOU ALREADY HAVE A COMBINATION BULLET AND POWDER SCALE

Try this simple test to see how sensitive your scale really is. Cut a piece of regular writing paper or this catalog 5/16 inch square. With scale set on zero—drop the paper on the pan to see if it moves. It should read about .1 grain. Keep adding paper squares until it does move. The total number of squares needed to move your scale is your scale's sensitivity. We have seen digital powder scales that are only sensitive to 1/2 grain (FIVE paper squares!) A Lee Safety Scale will move with the first paper.

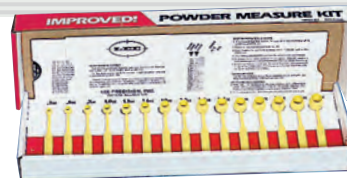

Lee Powder Measure Kit

Fifteen uniformly graduated and proportioned powder dippers. Slide card shows the grains of powder each measure will dispense of every type of powder. Powder measures are inherently safe as they cannot get out of adjustment. That's why powder dippers continue to be the first choice of reloaders who load in small quantities.

90100 **12.98**

Powder Funnel



A large, unbreakable funnel that fits all cases from .22 to .45 caliber. Hole in flange permits mounting to the Lee Turret Press, shelf or bench.

90190 **3.98**

The Original Perfect Powder Measure

Includes many of the features of the Classic Powder Measure, but the body is molded from an engineering grade polymer.

Rotating micrometer adjustable metering chamber and elastomer wiper to prevent powder cutting.

Works better than other powder measures priced four times as much.

Includes a free sturdy steel mounting bracket.

90058 **30.98**

Almost as good as a scale!

Solves problems common to ordinary drum type measures. Gives you the confidence that your charges will be the most uniform possible.

FREE STURDY STEEL MOUNTING BRACKET included with each measure



Selecting the right die set for your needs

RIFLE

LEE PACESETTER DIES and **RGB SERIES** For producing factory-dimensioned ammo that reliably fits and feeds in any gun. First choice for semi-auto actions. **FULL-LENGTH SIZING** is a must if you are reloading for more than one firearm or reloading cases that were fired in others firearms. **PACESETTER 3-DIE SETS** include the **LEE FACTORY CRIMP DIE**.

LEE COLLET NECK SIZING DIES

For best accuracy, longest case life and no resizing lubricant. Only the neck of the case is resized. The body is untouched—retains perfect fit to your guns chamber. Cases should have been fired in your firearm only and reloaded rounds are intended for use in just one firearm. These are the favorite of the bench rest crowd as there is no other die that can produce a more accurate cartridge.

If you intend to reload cases fired in others guns or you are reloading for more than one gun, select the **ULTIMATE RIFLE DIE SET**. The **ULTIMATE SET** includes a full length resizing die that allows you to restore any case to factory original dimensions so that you can fire form in your gun and then reload using the superior **COLLET NECK SIZING DIE**. **ULTIMATE RIFLE DIE SETS** include the **LEE FACTORY CRIMP DIE**.

The **LEE RIFLE FACTORY CRIMP DIE** is the only effective way to crimp bottle neck rifle cartridges. This important step should be performed on all loads used for hunting. Applying

a factory crimp will always improve the utility of the cartridge and in most cases it will also improve the accuracy.

HANDGUN

LEE HANDGUN DIES feature a **CARBIDE SIZING DIE**. Carbide dies are simply the best way to resize straight walled handgun cartridges.

The **STANDARD THREE DIE SET** works fine when using a quality controlled source of brass like cases fired only in your gun. More care is required when adjusting the bullet seat and crimp die as seating and crimping occur simultaneously.

Select the **DELUXE PISTOL DIE SET** when using mixed range brass or brass that was fired in others guns. The **DELUXE SET** includes the **CARBIDE FACTORY CRIMP DIE**. This die allows you to separate bullet seating from the crimping operation. It makes setup much easier and the die has the added feature of a carbide resizer that does a finishing sizing pass on the completed round. This final sizing guarantees that any case that passes through the die will freely and reliably chamber in any gun.

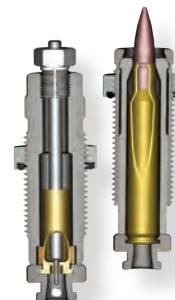

Best, most convenient

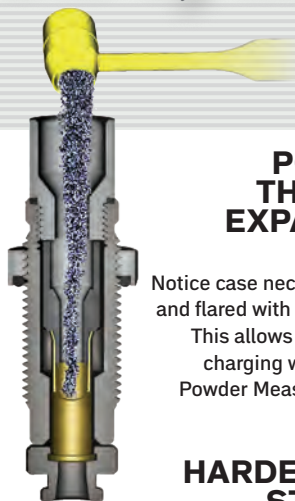

POWDER THROUGH EXPANDING DIE

Notice case neck is expanded and flared with a hollow plug. This allows simultaneous charging with Auto-Disk Powder Measure or dipper.

HARDENED STEEL SHELLHOLDER

POWDER MEASURE AND CHARGE TABLE

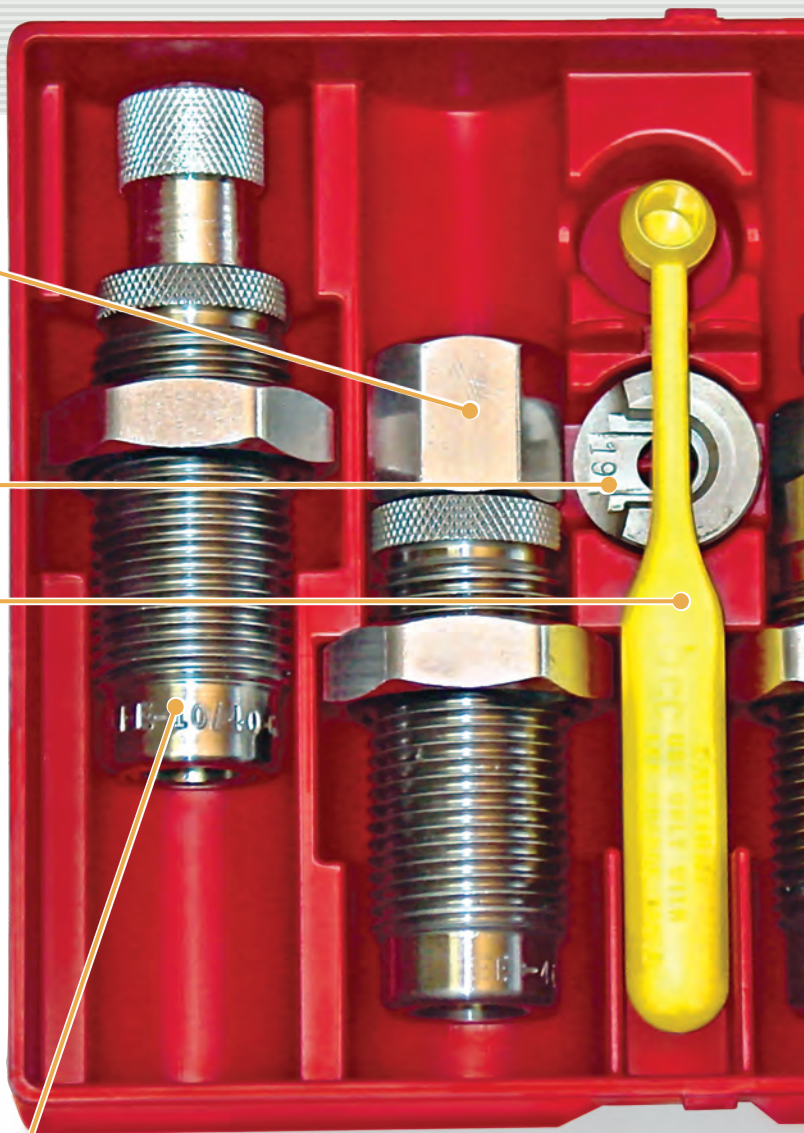

Lee Carbide Pistol Dies

We use a solid carbide insert, ground to a special contour that does not leave the objectional belt mark on the case, common to ordinary carbide dies. With a carbide sizer, no case lube is needed, and you don't even have to clean your cases.

No need for a taper crimp die; better accuracy with Lee Dies.

Taper crimp dies are used to correct the problems caused by the improper expanding plug design or adjustment. They distort the bullet shank and reduce accuracy. Because the Lee Expander flares the minimum amount, consistent with easy bullet insertion, all of the flare is removed with the bullet seating die, thus eliminating the need for a taper crimp die.

LEE CARBIDE 3-DIE SETS **42.98**

Lee Steel Pistol Dies

LEE STEEL 3-DIE SETS **41.98**

Same features as our premium carbide sets, except the case must be lubricated.

LEE RESIZING LUBRICANT
90006 3.98
See page 24.

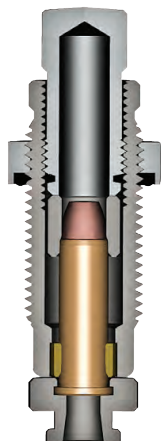

CARBIDE FACTORY CRIMP DIE

Carbide ring in base resizes any portion of case that exceeds factory new dimensions. Floating crimp ring is finger adjustable to provide the perfect crimp

Lee Deluxe Pistol Die Set

Combines the world's most popular carbide three-die set with the Lee Factory Crimp Die at a great price. No other die set at any price produces more reliable or accurate ammo.

By separating the seating and crimping operation, you will benefit by greatly simplified adjustment. More importantly, the Carbide Factory Crimp Die post sizes your case, assuring that any round that passes through the die will chamber properly in your gun. This, plus all the other exclusive features found on pages 22 and 23 — make this the best die set money can buy!

LEE DELUXE PISTOL 4-DIE SETS **59.98**

See charts on pages 22 and 23 for the complete list of Lee Pistol Dies

dies money can buy!



LEE CARBIDE DIES are used in commercial loading machines that cycle four to five thousand times per hour. You can't wear them out with personal use. These are the most copied dies ever invented. The competition tries to copy our dies, but come up short.

Only Lee has put it all together to make the best pistol dies money can buy. Reloaders buy Lee Dies because they are the best made and have the most features. No other brand can compare!

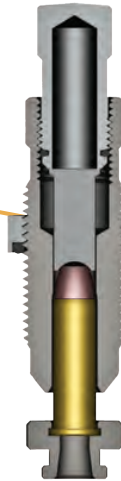

BULLET SEAT & FEED DIE

CONTOUR GROUND CARBIDE SIZING DIE

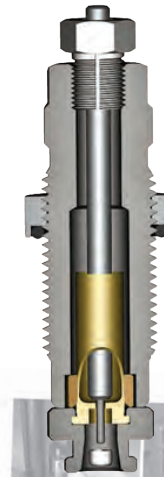

5 PRIME YOUR CASE using the LEVER PRIME SYSTEM or off the press using the Lee Auto Primer.

Install the correct primer arm (large or small) by simply hooking the primer arm over the cross pin in the ram. Place the proper type of primer in the primer guide. Using the Safety Prime greatly speeds this operation. See panel on reverse for details on the Safety Prime System.

Lower the ram to install the primer lift hard enough to seat the primer flush with the end of the case. Primers can be seated slightly below flush but never protruding.

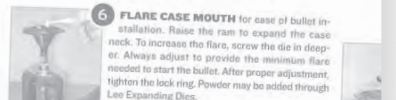

6 FLARE CASE MOUTH for ease of bullet installation. Raise the ram to expand the case neck. To increase the flare, screw the die in deeper.

Always adjust to provide the minimum flare needed to start the bullet. After proper adjustment, tighten the lock ring. Powder may be added through Lee Expanding Dies.

7 CHARGE THE CASE Regardless of how you charge the case, be absolutely certain you have the correct amount and type of powder for the bullet you have selected.

NEVER try to seat the primer deeper after the powder has been added.

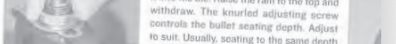

9 SEAT THE BULLET Place a bullet in the case mouth and guide it into the die. Raise the ram to the top and withdraw. The knurled adjusting screw controls the bullet seating depth. Adjust to suit. Usually seating to the same depth.

YOU CAN NOW BEGIN RELOADING



1 INSTALL SHELLHOLDER

INSTALL SIZING DIE While holding the handle against the stop, screw the die in until it touches the shell holder, then release pressure from the handle and screw the die in an additional 1/4 to 1/2 of a turn maximum. Now while holding the die, tighten the lock ring. NOTE: Carbide dies should not be screwed in the additional 1/4 to 1/2 turn.



3 PREPARE YOUR CASES Inspect your cases while lubricating them. Discard all cases with split necks, indications of head separation or other defects. Wipe on a thin film of Lee Case Lubricant with your fingers. Fingers are the best way of lubing a case as any cloth could damage the die is wiped away. The case may be improperly sized or you can let the lube dry.

CAUTION

For any reason you do not use Lee Resizing Lubricant, be very careful not to contaminate the powder or primers. Other brands are oil based and have serious, detrimental effects on powder and primers. Because of the stickiness, they also attract grit that can damage the die. Lee Resizing Lubricant costs less and is so superior that it is worth the

FITTED STORAGE BOX WITH LATCHING OR SLIP FIT COVER



We supply what you need, and what you want!

We've started millions in the fun and profitable hobby of reloading. Lee Precision is the only company that sells tools and dies with individualized instructions and load data. Every die set (except RGB Dies) has an instruction and data sheet specifically for that caliber.

FREE SHELLHOLDER INCLUDED



	59.98	42.98	41.98	28.98	13.98	13.98		5.98	3.98	2.98	14.98
25 ACP		90568		S/O	S/O				90002	90017	
30 M1 Carbine		90626▲		90617▲	90494		90421	90135	90524	90207	90365≈
30 Luger			90754		S/O		90175		90004	90023	
30 Mauser			90755		S/O		90086		90004	90023	
7.62 Tokarev			90769		S/O		90086		90004	90023	
32 ACP		90622		90621	S/O				90524	90207	
32 S & W		90696			S/O				90521	90204	
32 S & W Long ★		90624		90621	90490		90067	90169	90521	90204	
32 H & R Mag		90809		90621	S/O		90067		90521	90204	
32/20			90751		S/O		90851	90146	90523	90206	
38/40			90761		S/O		90852		90001	90272	
9mm Makarov		90176			S/O		90807	90684	90004	90023	90181
9mm Luger	90963	90509		90548	90580	90780	90860	90153	90004	90023	90032
357 Sig			90270		S/O		90076		90004	90023	
38 Short / Long Colt		90276			S/O				90518	90201	
38 Colt NP				90619	S/O				90518	90201	
38 Super/38 ACP		90623		90619	90482	90780	90866	90217	90004	90023	
380 Auto	90447	90625		90618	90492	90780	90867	90155	90521	90204	90025
38 S & W		90569		90619	S/O			90156	90518	90201	
38 Special ★	90964	90510		90530	90581	90781	90861	90157	90518	90201	90085
357 Magnum ★		90511		90530	90582	90781	90861	90158	90518	90201	90088

★ Can be used to load magnum cases ★ Can be used to load maximum cases * can be used to load the 475 Linebaugh ≈ \$10.98
 ▲ 30 M-1 Carbine \$17.00 extra * These dies do not include load data S/O Special Order Factory Direct

PISTOL DIE FEATURES

Carbide Sizer

All Lee straight sided pistol dies have tungsten carbide size rings. Carbide is so hard that it can only be ground and polished with diamond wheels.

This hard diamond polished surface eliminates the need for case lubrication and they will never wear out. Exclusive contour grind sizes closer to the rim than any other brand.

The collet held decapper is nearly unbreakable even if you misadjust it or deprime crimped primer military cases.

The decapper clamp collet accurately centers the decapper in the die. Should you over stress it for any reason, it harmlessly slides up without breaking. Easily reset with no limit to the amount of times it can be reset.

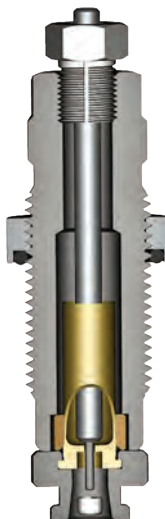

Powder Measure and Charge Table

Only Lee Dies come complete with a powder measure and charge table. An extensive list of proven loads that are safe and accurate. More extensive than some reloading manuals.



Storage is easy

Lee Dies are packed in a fitted box that allows dies to be returned to the box adjusted with or without the Lee Breech Lock bushing installed.

FREE SHELLHOLDER INCLUDED



FREE SHELLHOLDER included where shown

Others charge nearly \$13.00 for this necessary part.



	59.98	42.98	41.98	28.98	13.98	13.98	5.98	3.98	2.98	14.98	
40 S & W ★	90965	90799		S/O	90620	90782	90862	90154	90004	90023	90033
10mm Auto		90566		S/O	S/O	90782	90862	90127	90004	90023	90193
41 Mag		90628		90629	90630		90416	90159	90526	90209	90226
44 Special ★	90966	90516		90531	90583	90784	90863	90160	90528	90211	90107
44 Mag		90512		90531	90584	90784	90863	90161	90528	90211	90125
44 Russian		90293		90531	S/O		90863		90528	90211	
44/40			90564		S/O		90854	90168	90001	90272	
45 Colt ~	90967	90514		90533	90586	90786	90865	90163	90528	90211	90145
45 ACP	90968	90513		90532	90585	90785	90864	90162	90519	90202	90073
45 Auto Rim		90808		90532	90585	90785	90864		90199	90213	
45 Schofield		90323		90532	S/O	90785	90864		90001	90272	
400 Cor Bon			90430*		S/O		90173		90519	90202	
455 Web Mark II		90764		90533	S/O	90785	90865		90522	90205	
45 Win Mag		90810		90532	90585	90785	90864		90520	90203	
454 Casull		90795		90533	90586	90786	90865	90992	90528	90211	90174
45 Gap		90498		90532	S/O		90864	90224	90519	90202	
460 S & W		90344			S/O			90220	90001	90272	
480 Ruger ‡		90499			S/O			90018	90522	90205	
50 Action Express			90329		S/O				90528	90211	
500 S&W Mag		90288			S/O			90019	90003	90200	90178

★ Can be used to load magnum cases
* These dies do not include load data

* can be used to load the 475 Linebaugh
S/O Special Order Factory Direct

~ can be used to load the 454 Casull

Have a Breech Lock Press?

Breech lock bushings fit all Lee Breech Lock presses. Allows instant, accurate die changes.

BREECH LOCK BUSHINGS

90600 2-PK **10.98**

Perfect with Lee Lock Rings



New!

LOCK-RING ELIMINATOR

Breech lock quick change bushing with integral lock collar provides unmatched precision and convenience when adjusting dies. Split clamp positively locks die into position.

90063 2-PK **16.00**



EXCLUSIVE TO LEE

Free Shell Holder

The price of Lee Dies include a free shell holder of the proper size. Some manufacturers charge nearly \$13.00 extra for this necessary part.



Finger Tighten Lock Rings

Lock rings are easily adjusted and tightened with fingers only. No tools are needed. Yet they will never loosen or move while reloading.



Lee Bullet Seat and Feed Die

Universal free floating seating plug works with nearly any point style bullet. No need to change seater plugs for different nose types. Finger adjustable seating depth eliminates fumbling with pliers, lock nuts and screwdrivers to make simple seating depth adjustment. Die is tapered on end for use with automatic bullet feeders.

Lee Dies reload cartridges better, easier, more accurately and with fewer problems!



Powder Through Expanding Die

Only Lee Dies permit charging the case while expanding the case mouth. Every Lee 3-Die Set includes this **POWDER THROUGH EXPANDING DIE** at no extra cost. The powder funnel adapter can be replaced with a Lee Auto-Disk Powder Measure for fully automatic powder charging while the case mouth is being expanded.



BEST internal finish in the industry

All Lee dies are machine honed to the smoothest possible finish.

Don't confuse this with the surface polish that's used by most manufacturers. A polish simply makes a shiny surface. It's like trying to sand wood without backing under the sandpaper. The surface in Lee dies is progressively honed to a fine finish with no waves or ripples.

INCLUDES

- FULL LENGTH SIZER**
- EASY ADJUST DEAD LENGTH BULLET SEATING DIE**
- FACTORY CRIMP DIE**
- BUILT IN STUCK CASE REMOVER**
- EASY X EXPANDER**
- SHELL HOLDER**
- POWDER DIPPER**
- LOAD DATA & INSTRUCTIONS**



Lee PaceSetter™ 2-Die Set

The same features and quality of our standard dies, but do not include a Lee Factory Crimp Die. You'll find no better die at any price. Half the price of competitive dies and theirs don't include load data which is priceless on odd or obsolete calibers. Our dies also include the correct shellholder and powder measure. Includes SHELLHOLDER • POWDER DIPPER • LOAD DATA

LEE PACESSETTER 2-DIE SET **41.98**



RGB Dies REALLY GREAT BUY

Compare to other brands costing twice as much and you'll recognize what a fantastic bargain they are. We offer these only to show that when you buy Lee Dies — without all of the extras Lee customers have come to expect—the price is significantly lower, yet the quality is the best. Our tolerance is 50% less than the advertised amount of a popular and expensive brand. We guarantee these dies to be better than any other brand. If for any reason you're not 100% satisfied—just return them to the factory with your sales slip and pay the difference of what you paid and the manufacturer's catalog list price of the dies you want. We will ship them to you with our thanks for trying ours.

These dies are a **REALLY GREAT BUY**. They cost less, because like other die makers, we left out \$20.00 worth of extras which are included in our PaceSetter™ dies. Do yourself a favor and check our PaceSetter dies.

RGB SERIES DIES ONLY **25.98**



Lee PaceSetter™ 3-Die Set

INCLUDES THE EXCLUSIVE LEE FACTORY CRIMP DIE

LEE PACESSETTER 3-DIE SETS include the exclusive LEE FACTORY CRIMP™ DIE to produce factory-like ammunition with improved utility and accuracy. The die set also includes a conventional bullet seater. These dies are your best buy. They also include a shell holder, powder dipper, load data and are packed in the nicest storage box ever designed.

The extras represent a \$20.00 value. Most are unavailable at any price from other suppliers.

These are the most copied dies in the world. Each and every die comes with a written lifetime warranty, 2-year guarantee and guarantee of accuracy or your money back!

LEE PACESSETTER 3-DIE SET **41.98**



Lee Resizing Lubricant

Another first by Lee. We purchased the finest automotive deep draw lubricant and had it custom packaged exclusively for us. Lee lube is pleasant to handle and you can thin it with water. Non-sticky, nonallergenic. Very little is needed; it goes a long way. Eliminates stuck and dented cases and makes sizing less work.

2 OZ. TUBE 90006 **3.98**

**GUARANTEED TO LOAD
THE MOST ACCURATE
AMMUNITION
OR
YOUR MONEY BACK**

- NO LUBRICATION REQUIRED
- GUARANTEED ACCURACY
- EXTENDS CASE LIFE 10X
- FASTEST TO USE
- NO CLEANING OR LUBING REQUIRED

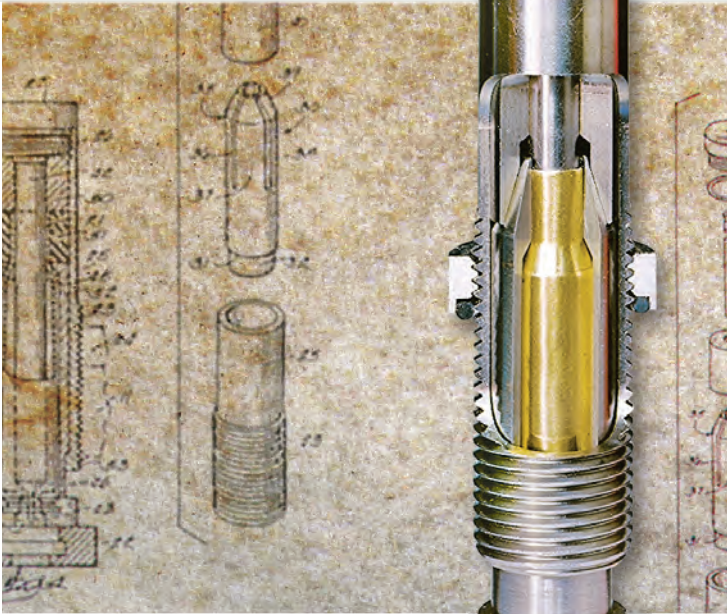

Lee Collet Dies

There is no loading system that will load more accurate ammunition than Lee Collet Dies. We guarantee it in writing with every set. No one but Lee has ever dared make a guarantee like this — Smallest group size or your money back. A collet squeezes the case neck against a precision mandrel for a perfect

bullet fit with minimum run-out. No case lube is needed. Cases last ten times longer, so the savings on only 35 cases will pay for the dies.

Maximum accuracy is usually achieved by seating the bullet out far enough to touch or almost touch the rifling. This provides the shot start pressure normally supplied by the crimp. That's

why a dead length bullet seater is included to complete the most accurate reloading system ever made. These dies size only the neck to preserve the perfect fit of fire forming. Only reload cases that have been fired in your gun. Not recommended for autoloaders, slide or lever action guns. See list of sizes on pages 26-27.

LEE COLLET DIE FOR NECK SIZING 40.98

Die sets include: Collet neck sizing die, dead length bullet seating die, shell holder, powder measure, charge table and storage box. Most calibers not listed can be custom made for \$70.00 plus shipping and handling. Send payment, two (2) fired cases and a bullet.

Lee Ultimate Rifle Die Set

Choose this die set for maximum versatility. The set features a full length-resizing die to return brass to factory new dimensions, perfect for reloading brass fired in other guns. The Collet Neck sizing die is used on your fire formed brass giving you best possible accuracy. No case lube required and cases last almost forever. The Easy Adjust Dead Length Bullet seating die foolproofs the bullet seating adjustment, and assures perfect seating depth every time. The Factory Crimp die provides a secure crimp on bullets with or without a crimp groove. In most cases it helps accuracy by providing a uniform higher start pressure and gives the finished cartridge Factory like accuracy and dependability.

The set is complete, with shell holder, powder measure and famous Lee load data featuring all common brands of powder organized in a easy to read logical format.

IN ADDITION TO BEST ACCURACY, YOU GET THESE BENEFITS

NO CASE LUBRICATION REQUIRED WITH COLLET DIE

REDUCED OR ELIMINATES CASE TRIMMING

A TEN TIMES INCREASED CASE LIFE

UNMATCHED SPEED AND CONVENIENCE

MINIMUM BULLET RUNOUT

MOST UNIFORM NECK TENSION

LEE ULTIMATE RIFLE DIE SET 65.00

Includes complete Collet Die Set plus Factory Crimp Die and full length Resizing Die. Requires RESIZING LUBRICANT



Lee Collet Dies accuracy contributes to world record

While competing in a regularly sanctioned 1000 YARD MATCH on July 25th, 1993, Robert Frey established a new 1000 yard world record. We're honored he used the Lee Collet Die to load his record setting ammunition.

World record breaker Robert Frey commented : "The Lee Collet Neck Sizing Die enables me to get top accuracy from my rifles (match and hunting). The design principle of sizing the case neck to a mandrel is unmatched for accuracy potential by any other dies. It is one of the best ways to make all of my rifles shoot their tightest groups."



A FEATURE IN ALL LEE RIFLE DIES

THE LEE EasyX EXPANDER

Collet type decapper clamp. Holds Easy X Expander perfectly centered in the die. Allows decapper to slide harmlessly up preventing decapper breakage if an obstruction is encountered.

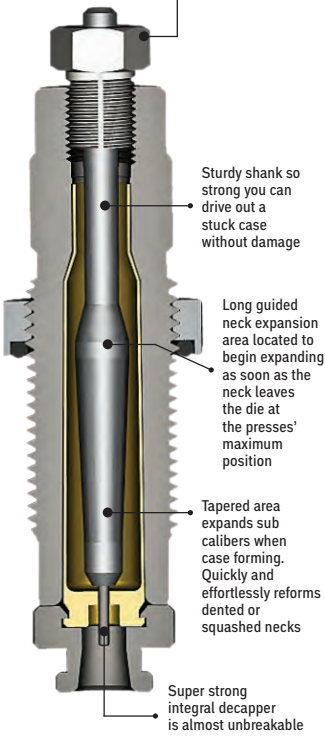

	25.98	41.98	41.98	40.98	65.00	26.98	15.98	5.98	3.98	2.98	10.98
17 Remington			90770	90804				N/A	90521	90204	90435
204 Ruger		90417		90734			90567	N/A	90521	90204	90439
22 Hornet		90500		90705			90829	90111	SD3590	90020	90354
218 Bee		90753					90830	90225	90523	90206	
221 Fireball		90549					90829	90112	90521	90204	
222 Remington	90870	90501		90706			90816	90113	90521	90204	90340
223 Remington	90871	90502		90707	90694	90954	90817	90114	90521	90204	90179
22/250	90872	90503		90708	90739	90955	90818	90116	90519	90202	90284
220 Swift		90542		90702			90831	90118	90527	90210	
223 WSSM			90446					90673	90522	90205	
243 Winchester	90873	90504		90709	90556	90956	90819	90119	90519	90202	90320
6mm PPC			90796	90802					90529	90212	
6mm Remington		90540		90710			90832	90120	90519	90202	90434
243 WSSM			90990				90187	90389	90522	90205	
25/20 WCF		90750					90833	90121	90523	90206	
25/35			90778						90520	90203	
250 Savage		90550					90834	90122	90519	90202	
257 Roberts		90551		90703			90835	90123	90519	90202	
260 Remington		90298		90974			90977	90993	90519	90202	90399
25/06 Rem		90536		90711		90957	90836	90124	90519	90202	90334
25 WSSM			90413					90221	90522	90205	
264 Win Mag			90774						90522	90205	
6.5 Carcano			90749					90043	90519	90202	
6.5 Japanese			90730						90527	90210	
6.5 Rem Mag			90773					90791	90522	90205	
6.5 x 55 Mauser	90874	90627		90712			90837	90126	90520	90203	90337
6.5 Creedmoor					90939		90704	90814	90519	90202	90812
270 Win Short Mag			90572				90962	90117	90522	90205	90393
270 Winchester	90875	90505		90713	90593	90958	90820	90128	90519	90202	90229
6.8 Rem SPC		90427					90735	90189	SD3391	90031	90397
7/30 Waters		90748					90838		90520	90203	
7 x 57 Mauser		90541		90714			90839	90130	90519	90202	90489
7 x 64 Brenneke		90771					90821	90236	90527	90210	
7mm/08		90537		90723			90840	90167	90519	90202	90343
7mm Express/280 Rem		90552		90724			90841	90166	90519	90202	90412
7mm Win Short Mag			90573					90314	90522	90205	
7mm Rem Mag	90876	90538		90720	90679		90821	90131	90522	90205	90297
7mm STW		90678					90869		90522	90205	
7mm Ultra Mag		90979					90869		90522	90205	
284 Winchester			90777					90129	90519	90202	
7.35 Carcano			90766						90519	90202	
7.5 x 55 Swiss		90767		90186			90184	90132	90520	90203	90419
7.5x54 MAS		90246					90842	90051	90520	90203	
7.62x39 Russian	90877	90565		90701			90827	90133	90529	90212	90345
7.62x 54 Russian		90731					90842	90147	90003	90200	90342

- RGB DIES p 24
- PACSETER 3-DIE SET p 24
- PACSETER 2-DIE SET p 24
- COLLET DIE SET p 25
- ULTIMATE RIFLE DIE SET p 25
- COLLET NECK SIZING DIE p 25
- FACTORY CRIMP DIE p 25
- CASE LENGTH GAUGE p 28
- UNIVERSAL SHELL HOLDER p 14
- AUTO PRIME SHELL HOLDER p 16
- QUICK TRIM p 15

Exclusive Lee features included at no extra cost*

Lee dies are the most copied dies ever made. Lately other brands have started to offer some previously exclusive Lee features. Such as one piece reaming, wrench flats, collet held decapper, finger adjustable bullet seater, elevated expander and "O" ring locks. The competition still remains way behind. Because Lee dies are made to the tightest tolerance

in the industry with unbreakable decappers, floating bullet seater, heat treated to maximum hardness and polished to the smoothest finish. Every Lee rifle die set comes with guaranteed best accuracy in writing. This is in addition to the regular 2-year guarantee and lifetime warranty. See back cover for a copy of the guarantee included with every Lee product!

* except RGB Dies



FACTORY CRIMP DIE

Most popular rifle die sets are equipped with a separate Factory Crimp Die. This is in addition to the regular combination bullet seater and crimper. Be sure to read about factory crimping on page 28.



FREE SHELLHOLDER included where shown
Others charge nearly \$13.00 for this necessary part.

RGB DIES p.24
PACESETTER 3-DIE SET p.24
PACESETTER 2-DIE SET p.24
COLLET DIE SET p.25
ULTIMATE RIFLE DIE SET p.25
COLLET NECK SIZING DIE p.25
FACTORY CRIMP DIE p.28
CASE LENGTH GAUGE p.14
UNIVERSAL SHELL HOLDER p.16
AUTO PRIME SHELL HOLDER p.16
QUICK TRIM DIE BODY p.15

	25.98	41.98	41.98	40.98	65.00	26.98	15.98	5.98	3.98	2.98	10.98
300 AAC Blackout		90575		90772			90590	90443	90521	90204	90689
30/40 Krag		90555					90843	90137	90522	90205	
30/30 Win	90878	90506		90716	90693		90822	90136	90520	90203	90249
303 Savage		90756					90823		90528	90211	
308 Winchester	90879	90507		90718	90695	90959	90823	90139	90519	90202	90231
300 Win Short Mag		90942		90185			90331	90034	90522	90205	90484
300 Savage		90545					90844	90138	90519	90202	
30/06	90880	90508		90715	90736	90960	90824	90140	90519	90202	90291
300 Win Mag	90881	90539		90722	90738	90961	90825	90142	90522	90205	90441
300 H & H		90560		90726			90970	90141	90522	90205	90407
300 Weatherby Mag		90558		90727			90845	90143	90522	90205	90408
300 Ultra Mag		90698					90970	90141	90522	90205	
7.65 Arg Mauser		90732					90846	90134	90520	90203	
7.7 Jap		90733					90847	90115	90519	90202	
303 British	90882	90547		90717			90826	90144	90522	90205	90325
32-40			90758						90520	90203	
32 Winchester			90757						90520	90203	
33 Winchester			90759						90525	90208	
325 WSM			90923					90222	90522	90205	
8x56 R Hungarian			90925					90589	90003	90200	
8x57 Mauser	90883	90544		90719			90848	90148	90519	90202	90347
8mm Lebel			90768						SD2827	N/A	
338 Winchester		90546		90721			90849	90149	90522	90205	90391
338 Lapua			90353				LARGE SERIES DIES—at right	90462	SD1351	SH2426	
338 Ultra Mag			90927						90522	90205	
348 Winchester		90760					90857		90525	90208	
350 Rem Mag			90776						90522	90205	
358 Winchester		90797					90904		90519	90202	
35 Remington		90543		90728			90828	90150	90519	90202	90403
35 Whelen			90752					90972	90519	90202	
38-56			90763						90525	90208	
375 H & H		90559		90729			90850	90164	90522	90205	90395
416 Remington		90805					90906		90522	90205	
43 Mauser			90806						SD2980	N/A	
43 Spanish			90765						SD2827	N/A	
32-20		90751*					90851	90146	90523	90206	
38-40		90761*					90852		90001	90272	
38-55		90762*					90853	90994	90520	90203	
375 Winchester		90563*					90905	90165	90520	90203	
40/65 Win		90986*							90525	90208	
44/40		90564*					90854	90168	90001	90272	
444 Marlin		90562*					90855	90151	90528	90211	
45/70 Govern		90561*•					90856	90152	90525	90208	90458
458 Win Mag		90800*					90969	90971	90522	90205	

3 DIE SETS WITH POWDER THROUGH EXPANDING DIE

*These dies do not include Factory Crimp Die • 45/70 Dies do not work on Hornady LEVERevolution cases

LOAD DATA & DIPPER

Complete load data with maximum and minimum suggested starting loads. This valuable data is not included with other brands and is unavailable anywhere for older and surplus cartridges.

LOCK RINGS

Finger tighten — set and forget, they never move. Just be sure to always loosen your dies by turning the ring, not the die. These have become so popular that we sell thousands of lock rings to people who want to update other brands.

LEE LOCK RINGS SET OF 3 90534 3.98



ROUND DIE BOX

lets you store dies installed in a 3 or 4-hole turret.

LEE DIE BOXES

Perfect storage for dies. Made from a tough, durable plastic.

ROUND DIE BOX 90535 4.98
FLAT 2-DIE BOX 90078 3.98
FLAT 4-DIE BOX 90422 4.98



Holds dies with Breech Lock Quick Change insert installed.

VERY LIMITED PRODUCTION PACE SETTER 2-DIE SETS #3-DIE w/FACTORY CRIMP

46.98

90980#	22/250 Ackley Improved
90981#	223 Ackley Improved
90982#	30/30 Ackley Improved
90983	416 Taylor
90984	6mm/284 Win
90985	6.5/300 Win Short Mag
90987	338/06
90988#	257 Ackley Improved
90989#	280 Ackley Improved
90951	30/284
90411	41 Swiss*
90214	40/60*
90215	45/60*
90216	45/75*

3-Die Sets

1/4-12 Thread Series Factory Crimp Dies

50.00

90953	50 BMG
90745	338 Lapua

1/4-12 Thread Series Collet Dies

125.00

90747	50 BMG
-------	--------

1/4-12 Thread Series Dies

125.00

90902	577/450 Martini-Henry*
90929	577 Snider*
90252	416 Barrett* Shellholder not included
90515	50 BMG Shellholder not included

*These dies do not include load data

Do you have a Breech Lock Press?

You may want bushings Breech lock bushings fit all Lee Breech Lock presses. Allows instant, accurate die changes.

BREECH LOCK BUSHINGS

90600 2-PACK 10.98
Perfect with Lee Lock Rings



LOCK-RING ELIMINATOR

Breech lock quick change bushing with integral lock collar provides unmatched precision and convenience when adjusting dies. Split clamp positively locks die into position.

90063 2-PK 16.00



OVERCOMES THE FACTORY AD

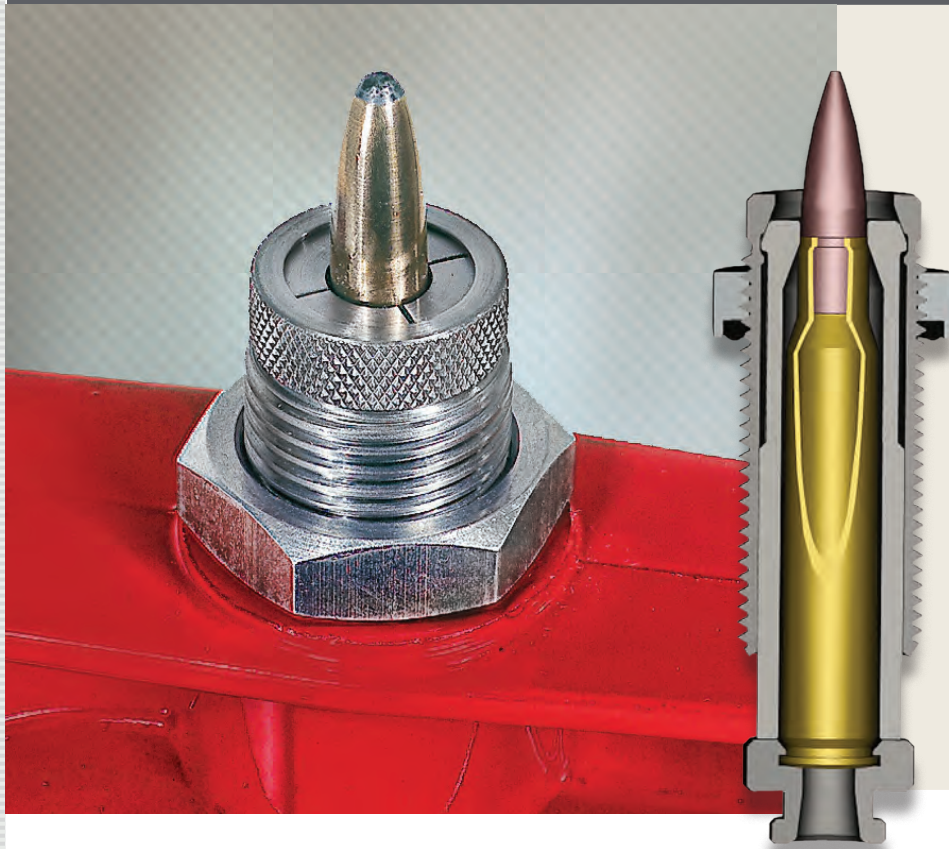

Lee Factory Crimp Die

The Lee Factory Crimp Die crimps the bullet in place more firmly than any other tool. It is impossible to buckle the case as with regular roll crimp dies. Trim length is not critical. Tests demonstrate that even bullets which have no cannelure will shoot more accurately if crimped in place with the Lee Factory Crimp Die.

Factory ammunition is often more accurate and better able to withstand rough handling because the bullet is firmly crimped in place. A firm crimp improves accuracy because pressure must build to a higher level before the bullet begins to move. This higher start pressure insures a more uniform pressure curve and less velocity variation. Even powder selection is less critical. Until now, handloaders seated the bullet to touch the rifling to achieve similar results. This is not always possible nor desirable. The Lee Factory Crimp Die is included at no extra charge with Lee PaceSetter 3-Die Sets. It's just another added value that only Lee Dies offer.

LEE FACTORY CRIMP DIE **15.98**

**NO CRIMP GROOVE REQUIRED
EVEN WITH JACKETED BULLETS**

For handgun ammunition that must work!

Lee Carbide Factory Crimp Die



A carbide sizer sizes the cartridge while being crimped so every round will positively chamber freely with factory like dependability. The adjusting screw quickly and easily sets the desired amount of crimp. It is impossible to buckle the case as with a conventional bullet seating die. Trim length is not critical so this extra operation takes less time than it would if cases were trimmed and chamfered.

Revolver dies roll crimp with no limit as to the amount. A perfect taper crimp is applied to auto-loader rounds. The crimper cannot be mis-adjusted to make a case mouth too small to properly head-space. A firm crimp is essential for dependable and accurate ammunition—it eliminates the problems of poor ignition of slow burning magnum powders.

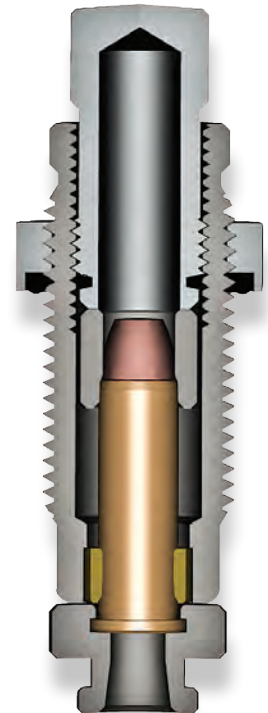

CARBIDE FACTORY CRIMP DIE **22.98**

32 S&W LONG – 32 H&R	90067	ROLL
9 mm LUGER	90860	TAPER
9 mm MAKAROV	90807	TAPER
380 AUTO	90867	TAPER
38 SUPER & 38 ACP	90866	TAPER
38 SPECIAL & 357 MAGNUM	90861	ROLL
40 CALIBER S&W, 10MM AUTO	90862	TAPER
41 MAGNUM	90416	ROLL
44 MAGNUM, SPECIAL, RUSSIAN	90863	ROLL
45 COLT & 454 CASULL	90865	ROLL
45 ACP, 45 AUTO RIM, GAP	90864	TAPER

Special Sizes available \$30.00

VANTAGE

FACTORY CRIMP DIE SIZES

22 HORNET	90829
204 RUGER	90567
218 BEE	90830
222 REMINGTON	90816
223W	90817
22/250	90818
220 SWIFT	90831
243 WINCHESTER	90819
6MM REMINGTON	90832
243 WSSM	90187
25/20	90833
250 SAVAGE	90834
257 ROBERTS	90835
25/06	90836
6.5 CREEDMOOR	90704
6.5 GRENDL	90596
6.5X55	90837
6.8 SPC	90735
260 REMINGTON	90977
270 WINCHESTER SHORT MAGNUM	90962
270 WINCHESTER	90820
7/30 WATERS	90838
7X57 MAUSER	90839
7mm/08	90840
7mm EXPRESS	90841
7mm REMINGTON MAGNUM	90821
7mm STW	90869
7.62X39 RUSSIAN	90827
7.62X54 RUSSIAN	90842
32/20	90851
30 M-1	90421
300 AAC BLACKOUT	90590
30/40 Krag	90843
30/30 WINCHESTER	90822
308 WINCHESTER/303 SAVAGE	90823
300 SAVAGE	90844
30/06	90824
30/284	90066
300 WINCHESTER SHORT MAGNUM	90331
300 WINCHESTER MAGNUM	90825
300 WEATHERBY MAGNUM	90845
300 ULTRA MAG/300 H&H	90970
7.5X55	90184
7.65 ARGENTINE MAUSER	90846
7.7 JAPANESE	90847
303 BRITISH	90826
8X57 MAUSER	90848
348 WINCHESTER	90857
338 WINCHESTER / 338-06	90849
35 REMINGTON	90828
356 & 358 WINCHESTER	90904
38/40	90852
38/55	90853
375 WINCHESTER	90905
375 H&H	90850
416 REMINGTON	90906
44/40	90854
444 MARLIN	90855
45/70 GOV / 450 MARLIN	90856
458 WIN MAGNUM	90969
1¼-12 THREAD FACTORY CRIMP DIES	50.00
50 BMG	90953
338 LAPUA	90745

Most calibers not listed can be custom made for \$25.00 plus shipping and handling. Available only from the factory. Allow six weeks and supply a bullet seated in empty case.



Bottle Neck Pistol Factory Crimp Die

Incorporates a collet to apply a rifle type crimp to the case. Makes these very difficult to crimp cartridges a delight to reload. Bullets do not need a crimp groove, as the collet is so powerful it will form one.

30 LUGER	90175	357 SIG	90076
30 TOKAREV & 30 MAUSER	90086	400 COR-BON	90173
5.7 X 28 FN	90725		

BOTTLE NECK PISTOL FACTORY CRIMP DIE **25.00**

Taper Crimp Die

The Lee Taper Crimp Die is hardened steel designed to overcome crimp problems caused by poor die design. These dies offer little or no advantage when used with 1986 or newer Lee Dies as the crimp angle is already a modified taper crimp. Jacketed bullets must have a crimp groove.

9 mm LUGER	90780	45 COLT	90786
38 SUPER AND 38 ACP	90780	45 ACP, 45 AUTO RIM	90785
38 SPECIAL	90781	455 WEBLEY MARK II	90785
357 MAGNUM	90781	45 WIN MAGNUM, 45 GAP	90785
10 mm AUTO / 40 S&W	90782	454 CASULL	90786
44 SPECIAL, 44 MAGNUM	90784		

TAPER CRIMP DIE **13.98**



Lee Bulge Buster Kit will help you save your brass



Utilize all your brass by removing annoying bulge rings

With the Lee Factory Crimp Die, the Bulge Buster will repair all these rimless cases

*9 mm LUGER
380 ACP
10 mm
40 S&W
41 AE
45 ACP
45 GAP
45 WIN MAG

*9 mm Makarov #90807 Factory Crimp must be used

Catch Container



Push through Punch
Extension Sleeve

Lee Bulge Buster Kit

Assure your mixed brass is bulge free with the Bulge Buster Kit and appropriate Lee Factory Crimp Die. This push through die adapter will quickly remove the annoying bulge rings that shell holder constrained dies simply can't reach. The Bulge Buster Kit includes extension sleeve, push through punch, catch container and complete instructions.

And it's fast— you can reprocess your cases as quickly as you can handle them.

BULGE BUSTER KIT 90487 **19.98**



Lee Pro 4-20

Large diameter high capacity pot, holds approximately 20 pounds of lead. Nearly 4 inches of clearance under the spout accepts all brands of bullet molds and most sinker molds. It also includes an adjustable mold guide to quickly and accurately position any mold for pouring.

This second generation design incorporates the famous Lee patented high-efficiency design and dependable remote sensing thermostat, now in a dust tight housing. Long life 700-watt tubular heating element assures quick melting and rapid recovery. New micro adjustable, flow control valve adjusts instantly with a twist of the screw driver. Front mounted low maintenance replaceable valve spout allows instant reseating with a turn of a screwdriver.

LEE PRO 4-20	90947	110 VOLT	96.98
LEE PRO 4-20	90948	220 VOLT	101.00

UNIQUE INFINITE HEAT CONTROL

A highly reliable control, mounted away from the high heat of the pot. Eliminates failures usually associated with thermostatically controlled units. Thermal feed back to the infinite control permits heater to put out full power until metal has melted.



Magnum Melter

Large 4" diameter pot allows easy access for the ladle caster. Same high efficiency design that has made Lee pots the most popular. Melt time is less than 20 minutes with just 700 watts. 20-lb. capacity for the longest casting session.

MAGNUM MELTER	90949	82.00
---------------	-------	--------------

Lee makes bullet casting easier



Lee Precision Melter

High speed melter with an infinite heat control for the serious shooter. Easily handles 4-cavity molds. Takes less than 15 minutes to melt 4 pounds of metal. Same infinite heat control as used on the Production Pot. 500 watts AC only. Guaranteed 2 years.

PRECISION MELTER, 110V	90021	45.98
EXPORT MODEL, 220V	90024	49.98



Lee Production Pot IV

Large, deep pot holds approximately 10 pounds of lead. Melt time is less than 20 minutes. Pour spout up front where it belongs so you can see what you're doing. Infinite heat control. Uses only 500 watts of power during heat-up and a lot less to maintain temperature. Large, stable base for safety. 4" of clearance under the spout is high enough to accept all brands of bullet molds and most sinker molds.

PRODUCTION POT IV	110 VOLT	90009	79.98
EXPORT MODEL	220 VOLT	90008	85.98



WARNING MELTING LEAD AND CASTING LEAD OBJECTS WILL EXPOSE YOU AND OTHERS IN THE AREA TO LEAD, WHICH IS KNOWN TO CAUSE BIRTH DEFECTS, OTHER REPRODUCTIVE HARM AND CANCER. SEE INSTRUCTIONS ON "REDUCING EXPOSURE" SUPPLIED WITH PRODUCT.



LEE INGOT MOLD

Use to cast 1/2 and one pound ingots. Perfect for remelting and alloying. Wood handles stay cool. Aluminum mold is lightweight and rustproof.

90029	14.98
-------	--------------

LEE LEAD LADLE

A convenient size ladle for bullet casting. Works equally well for right and left handers. Handy for skimming and stirring metal.

90026	6.98
-------	-------------

Lube & Sizing Kit

Fastest and easiest way to lubricate and size cast bullets. Standard 7/8 x 14 threads fit any reloading press. Bullets are pushed through the sizing die nose first, so no special nose punches are needed. Gas checks are automatically seated and crimped in place. Sized bullets are captured in the special container. A 4 oz. bottle of LEE LIQUID ALOX BULLET LUBE — a \$6.98 value — included free, is enough for thousands of bullets.

COMPLETE FOR ONE SIZE PRESS NOT INCLUDED **26.98**

90049	.224	90686	.323	90054	.429
90036	.225	90934	.329	90062	.430
90083	.243	90576	.339	90061	.451
90170	.284	90046	.356	90055	.452
90171	.285	90047	.357	90056	.454
90037	.308	90048	.358	90057	.457
90038	.309	90060	.401	90191	.501
90039	.311	90052	.410	90188	.510
90044	.314	90053	.427		

Other sizes can be made on a special order basis for \$34.00, plus shipping & handling.

Universal Case Expanding Die

Gently flares the case mouth to accept cast bullets without shaving. Works great to prevent damaging the moly and low friction coatings found on today's high performance jacketed bullets. Includes neck plugs for .22 cal through .45 cal. Works on everything from the 22 Hornet to the largest Ultra Mag. Costs so little and works so well you can't afford to be without one.

90798 **16.98**



Hardness Testing Kit

Featured product in CHAPTER 10 of *Modern Reloading*. No more wasted components shooting too soft or too hard lead. Cast and load with confidence knowing your alloy is up to the job. Quickly and precisely check hardness of your lead alloy. Exclusive conversion chart tells the maximum operating pressure of any lead alloy.

90924 **86.00** INCLUDES calibrated hardened steel ball indenter "V" block cradle snaps into standard press ram 20 power 4 lens optical measuring microscope

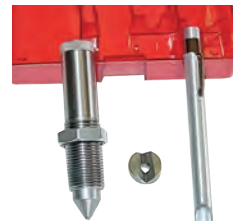

**Try this
with your
bullet lubricant!**

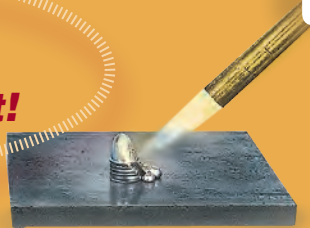

**The bullet melts
while the
Lee Liquid Alox
clings tenaciously
to the bullet**



Lee Liquid Alox Enough for thousands of bullets

Lee Liquid Alox gives better accuracy because it eliminates leading. The lube coats the entire bullet like a thin jacket and dries to a soft, varnish-like finish that really clings. The dried coating does not degrade gunpowder. Easy to apply; eliminates the need for sizing of most cast bullets. While it works well with all cast or swaged bullets better than any other lube, it works best with micro band bullets, which are designed for tumble lubing. Marked with a TL on page 33.

4 OZ. DISPENSER BOTTLE 90177 **6.98**

LUBRICATING BULLETS

Traditional bullet lubricating methods of placing lube only in the grooves are inferior to the modern method of coating the entire bullet with Lee Liquid Alox. This places the lube where needed, on the surfaces that rub against the bore.

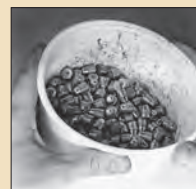

Gently shake the bullets in an orbital motion to coat the bullets. If they do not coat completely, add a little more lube.



Spread the bullets onto waxed paper and let dry overnight.

LEE BULLET MOLDS

Detail of trochoidal vent grooves



Lee molds now feature **trochoidal venting** on the mold face and sprue plate mating surface. This unique venting allows consistent and effortless fill out.

All Lee Mold Blocks are made from aluminum because of the exceptional molding qualities

The mold cavities are CNC machined for unmatched roundness and size control

Most bullets from Lee molds can be used as cast without sizing



MOLD NUMBER CODE

C	309	180	R
GAS CHECK	DIAMETER	WEIGHT IN GRAINS	POINT SHAPE
TL Micro Bands for Tumble Lubing with Lee Liquid Alox			WC Wad Cutter SWC SemiWad Cutter RF Round with Flat R 1 Ogive Radius 2R 2 Ogive Radius TC Truncated Cone

DOUBLE CAVITY MOLDS

Handles and sprue plate included. **26.98**

HOLLOW BASE MOLDS

These are available in single cavity only. They all have self centering automatic core pins for the fastest possible molding. Handles and sprue plate included. **30.98**

SIX CAVITY COMMERCIAL QUALITY MOLDS

These are made for heavy duty volume production. The mold and blocks have steel bushing and alignment pins for lasting precision. Price includes a cam operated sprue plate to eliminate the pounding common to ordinary molds. The sprue plate is hard anodized and held down with wave washers at each end. No finer mold can be purchased at any price. Handles extra. **53.00**

MOLD HANDLES

Precision steel mold handles fit not only the Lee Six Cavity blocks, but most other brands of one and two cavity molds. Priced low enough so you can have a set for every pair of blocks.

LEE MOLD HANDLES 90005 **17.98**

SHOTGUN SLUG AND BUCKSHOT MOLDS

SEE PAGE 35



Designed for liquid tumble lubricating

Micro Band Bullets

usually require no sizing

A great innovation possible only because of Lee Liquid Alox Lubricant. The bullet shank has many shallow grooves for maximum lubricant retention.

They all have a bevel base just behind a solid driving band. A great way to make bullets in quantity with minimum time, effort and equipment. More accurate than ordinary cast bullets.



Custom Molds

We can produce custom bullet molds within certain limits. The prices are the same as our standard molds, but there is a tooling and set-up charge of \$175.00. If interested in this service, please send a self-addressed stamped envelope for a design assistance sheet, which outlines the basic limitations of our manufacturing process.



NOTE Design assistance sheet also available on www.leeprecision.com











WARNING Melting lead and casting lead objects will expose you and others in the area to lead, which is known to cause birth defects, other reproductive harm and cancer. See instructions on "Reducing Exposure" supplied with product.

	32/20 · 32S&W LONG 32 COLT NP			38 SPECIAL · 38 S & W · 38 COLT NEW POLICE · 357 MAG <i>Works great in 9mm Luger</i>									
													
BALLISTIC COEFFICIENT	.125	.174	.100	.106	.116	.142	.072	.072	.131	.117	.117	.207	.160
	311-93-1R	311-100-2R	TL314-90-SWC	358-105-SWC	358-125-RF	358-140-SWC	TL358-148-WC	358-148-WC	358-150-1R	TL358-158-SWC	C358-158-SWC	TL358-158-2R	358-158-RF
DOUBLE	90300	90301	90311	90316	90574	90318	90279	90312	90328	90321	90322	90388	90303
6 CAVITY	90308			90315	90306	90317	90294	90380	90326	90295	90327	90319	90692

	9mm LUGER · 38 SUPER AUTO · 380 AUTO						9mm MAKAROV	40S&W · 10mm			41 MAGNUM		44 SPEC · 44 MAGNUM · 44/40		
															
BALLISTIC COEFFICIENT	.107	.105	.123	.164	.127	.166	.093	.117	.141	.141	.110	.119	.111	.124	.124
	TL356-95-RF	356-102-1R	356-120-TC	TL356-124-2R	TL356-124-TC	356-125-2R	365-95-1R	401-145-SWC	TL401-175-SWC	401-175-TC	410-195-SWC	TL410-210-SWC	429-214-SWC	C429-240-SWC	429-200-RF
DOUBLE	90601	90305	90239	90464	90238	90309	90466	90470	90431	90256	90330	90335	90336	90338	90285
6 CAVITY	90672		90387	90465	90402	90457			90433	90690				90483	90428

	44 SP · 44 MAG · 44/40			45 ACP · 45 AUTO RIM · 45 COLT									
													
BALLISTIC COEFFICIENT	.196	.169	.218	.090	.127	.140	.127	.145	.189	.146	.146	.136	.210
	429-240-2R	TL430-240-SWC	C430-310-RF	452-160-RF	452-200-SWC	452-200-RF	TL452-200-SWC	452-228-1R	TL452-230-2R	TL452-230-TC	452-230-TC	452-252-SWC	452-255-RF
DOUBLE	90341	90299	90858	90570	90348	90234	90463	90351	90346	90287	90290	90356	90358
6 CAVITY	90339	90357	90227		90310	90697	90379	90352	90350	90286	90289		90349

	45 COLT 454 CASULL	480 RUGER 475 LINEBAUGH	500 S&W	7 mm	30 CALIBER RIFLE								7.62x39 <small>Bullet Design by C.E. Harris</small>		
															
BALLISTIC COEFFICIENT	.233	.256	.271	.296	.305	.154	.163	.224	.252	.268	.317	.352	.688	.268	.276
	C452-300-RF	C476-325-RF	476-400-RF	C501-440-RF	C285-130-R	C309-113-F	C309-120-R	C309-150-F	C309-160-R	C309-170-F	C309-180-R	C309-200-R	TL309-230-5R	C312-155-2R	CTL312-160-2R
DOUBLE	90359	90237	90241	90991	90360	90362	90364	90366	90367	90368	90369	90370	90307	90385	90361
6 CAVITY	90228														

	303B	8mm	8 x56	338 CAL	375 Win 38/55	45 - 70 CALIBER RIFLE HOLLOW BASE						50-70 CAL		
														
BALLISTIC COEFFICIENT	.247	.216	.361	.250	.250	.211	.225	.250	.250	.250	.278	.443	.220	.283
	C312-185-1R	C324-175-1R	C329-205-1R	C338-220-1R	379-250-RF	457-340-F	457-405-F	459-405-HB	457-450-F	C457-500-F	459-500-3R	515-450-F	515-500-F	
DOUBLE	90371	90274	90775	90372	90324	90373	90374		90375	90376	90577	90255	90266	
HOLLOW								90268						



Minie Bullet Mold

Automatic Core Pin Mold. Open the mold upside down to empty. Close it and you're ready to cast the next. The core pin automatically centers in the mold. Easily cast 200 per hour. A quality mold built to last as long as your rifle.

COMPLETE W/ HANDLES AND AUTOMATIC CORE PIN **30.98**



Original Style Minie Bullet

58 Caliber 575-500M 90481

An extremely popular, traditional size Minie bullet. Available in 58 caliber only. Certainly a must for authentic muzzle loading shooting.



Round Ball Molds

Have tangential cut off which eliminates the objectional nib at the sprue.

DOUBLE CAVITY WITH HANDLES **26.98**
12-CAVITY WITHOUT HANDLES **64.00**

Cast Minie Bullets as fast as Round Balls



Improved Minie, Traditional Design

45 Cal.	.450-294M	90467
45 Cal. oversize	.454-298M	90469
50 Cal.	.500-360M	90472
54 Cal.	.533-410M	90473
54 Cal. oversize	.540-415M	90474
58 cal.	.575-472M	90476
58 cal. oversize	.578-478M	90478

Improved design is easier to cast and load. Usually more accurate; a wider variety of sizes.



Modern Minie, Target Design

50 Cal. .500-354M 90471
58 Cal. .575-470M 90475

The most accurate of all Minies. Makes nice, clean holes in the target. The first choice for highest scores.

SIZE	DOUBLE	SIZE	DOUBLE	SIZE	DOUBLE	SIZE	DOUBLE
.311	90406	.395	90425	.490	90448	.600	90975
.319	90410	.433	90432	.495	90450	SIZE	SINGLE
.350	90415	.440	90436	.500	90452	.690	90978*
.360	90418	.445	90438	.530	90283	Due to the diameter, mold ships as a single cavity.	
.375	90420	.451	90440	.535	90456	SIZE	12-CAVITY
.380	90423	.454	90442	.562	90460	.490	90691▲
.390	90424	.457	90444	.575	90461	▲ Handles #90005 17.98	

New

R·E·A·L BULLET FOR MUZZLELOADERS

RIFLING · ENGRAVED · AT · LOADING

A solid bullet that loads easily even after many firings because of its unique cleaning action. Will not tumble. A perfect hunting bullet with heavy loads. Easy to cast. Shoots accurately even in greatly oversize barrels.

DOUBLE CAVITY WITH HANDLES **26.98**



	Grains	Double
45 Cal.	200	90390
45 Cal.	250	90392
50 Cal.	250	90394
50 Cal.	320	90396
54 Cal.	300	90398
54 Cal.	380	90400
58 Cal.	440	90404

Combo Molds

45 CAL 200RB WITH HANDLES 90405 **26.98**

This double cavity mold will cast one 45 Cal. 200 R.E.A.L bullet and one .440 diameter Round Ball.

50 CAL 320RB WITH HANDLES

90488 **26.98**

Double cavity mold casts one 50 Cal. 320 R.E.A.L bullet and one .490 diameter Round Ball.

RIFLING-ENGRAVED-AT-LOADING The driving bands are large enough to adequately engage the rifling when pushed into the muzzle, and thin enough to easily engrave. They're strong enough to withstand maximum charges without stripping or gas cutting.

UNIQUE CLEANING ACTION You can shoot all day without cleaning your rifle between shots! When inserted into the muzzle, tiny scraping edges are swagged forward on each driving band. These perfect fitting scrapers remove the fouling from the previous shot.

EASIER, FASTER TO LOAD It's easy to load straight and true, easier and faster than a round

ball with patch. Easily stabilized with very light charges, the R-E-A-L bullet also retains accuracy with maximum loads. Each band is generously tapered to the rear with an angle close to that of a lathe center, so as to center the bullet against the rifle bands. When pushed in, the bullet automatically centers in the bore.

MORE ACCURATE The bevel base of the R-E-A-L bullet contributes to greater accuracy. When the bullet exits the bore, the gas escapes equally around the perimeter of the base. The uniform bevel is resistant to nicks that would permit gas to escape prematurely and cause a jet effect on one side of the bullet.

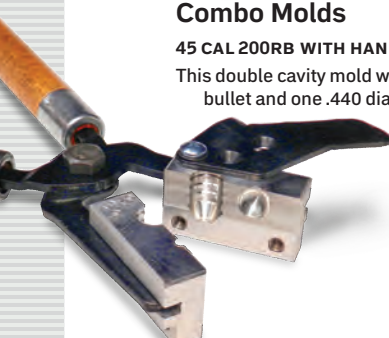

Conical Bullet Mold for black powder revolvers

A super accurate bullet that is easy to load straight and true. Two lube grooves prevent flash ignition and lead fouling. More energy and far greater accuracy than round balls.

36 Cal.	375-130-1R	26.98
		DOUBLE
		90378
44 Cal. Rem.	450-200-1R	90382
44 Ruger Old Army	456-220-1R	90384

WARNING MELTING LEAD AND CASTING LEAD OBJECTS WILL EXPOSE YOU AND OTHERS IN THE AREA TO LEAD, WHICH IS KNOWN TO CAUSE BIRTH DEFECTS, OTHER REPRODUCTIVE HARM AND CANCER. SEE INSTRUCTIONS ON "REDUCING EXPOSURE" SUPPLIED WITH PRODUCT.

**Load shotgun shells,
steel or lead shot,
to look and shoot
like new**

Lee Load-All II

Lee Load-All II shotgun shells not only look better than those loaded on machines costing hundreds of dollars, but they usually have more uniform velocity and patterns. You can load just as fast as with any other brand of loader costing up to \$200.

Twenty-four shot and powder bushings are included free. The bushings alone can cost several dollars each from other manufacturers—and they're not as accurate as those made by Lee. Only Lee supplies molded bushings.

This is a time proven tool. There are hundreds of thousands in use world wide: in nearly forty years, we have yet to see one worn out. Written two-year unconditional guarantee and a lifetime warranty.



Load-All Options

CONVERSION TO ANOTHER GAUGE

The Load-All II can be easily and economically converted to another gauge with the conversion kit. The entire die carrier is replaced so no adjustments are needed. The conversion kit includes the die carrier, steel sizer, wad guide, shell holder, load data and instructions.

**CONVERSION KIT
25.98**

12 GAUGE	90070
16 GAUGE	90071
20 GAUGE	90072

**LEE ADJUSTABLE
SHOT DIPPER**

Accurately measure lead, bismuth and steel. Telescoping cup adjustable from 7/8 to 1 7/8 oz. Calibrated for lead shot. Works perfect for large pellet sizes. With steel, simply count out pellets or weigh and set dipper accordingly.

90973 **3.98**



LEE LOAD-ALL II	75.98
12 GAUGE	90011
16 GAUGE	90015
20 GAUGE	90012



**LOAD SLUGS
FOR LESS
THAN STANDARD
TRAP LOADS**

Lee Slug Mold

Load slugs for less than standard trap loads. The LEE DRIVE KEY slug is loaded in standard trap hull with standard wad and conventional folded crimp. Slug loads are produced with any standard shot shell reloading press.

Lee Slug Mold features the exclusive drive key. The drive key positively rotates the slug in rifled shotgun barrels and doubles as a support rib allowing use of a standard trap wad—no need for a support wad or base filler. Sabot wad design outperforms rifled slugs in rifled slug barrels. Velocity and accuracy meet and exceed expensive factory loaded rifled slugs. Molds feature self centering automatic core pins for maximum speed and convenience. Mold is complete with sprue plate, handles and complete instructions with suggested loads.

SHOTGUN SLUG MOLD	1 OZ.	12 GA.	90281	30.98
SHOTGUN SLUG MOLD	7/8 OZ.	12 GA.	90282	30.98

Exclusive Drive Key positively rotates the slug in rifled barrels and eliminates the need for support wads or base fillers; assures positive and smooth discard of the sabot wad.

*Guaranteed more accurate than
factory slugs or your money back*

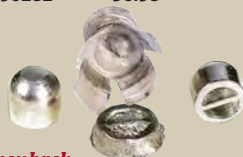

**18 CAVITY BUCKSHOT
BULLET MOLDS**



**Lee 18 Cavity
Buckshot Bullet Molds**

Precision-machined molds produce 18 linked pellets per cast. Each cast produces enough pellets to load two 12 Gauge shotshells. Easily cast 3,000 pellets per hour. Handles shown not included. Order product no. 90005 on page 32.

BALL DIAMETER .240 #4 BUCKSHOT	90028	64.00
BALL DIAMETER .330 00 BUCKSHOT	90486	
BALL DIAMETER .360 000 BUCKSHOT	90192	
HANDLES	90005	17.98



THE LEE GUARANTEE

Lee Reloading Products are guaranteed not to wear out or break from normal use for two full years or they will be repaired or replaced at no charge, if returned to the factory. Any Lee product of current manufacture, regardless of age or condition, will be reconditioned to new, including new guarantee, if returned to the factory with payment equal to half the current retail price!

LEE

Breech Lock · Classic Cast · Load-Master · Lever Prime System · Lee Loader · Load-All II
RGB · Factory Crimp · PaceSetter · Perfect Powder Measure · Safety Scale · Auto-Prime
Bulge Buster · Micro-Band Drive Key · R-E-A-L and ZipTrim are trademarks of Lee Precision, Inc.
4275 HIGHWAY U HARTFORD WISCONSIN 53027 262 673 3075

PRINTED IN USA | 122014

www.leeprecision.com